

Hybrid AF™ Convergent Therapy and Left Atrial Appendage Exclusion Physician Training Guide

————— for Sub-Xiphoid Access; Epicardial Ablation and Left Atrial
Appendage Ligation Utilizing Epi-Sense ST and AtriClip Exclusion Device



This material is intended to provide and reinforce previous training addressing the closed-chest approach options and is intended for educational purposes only. Such information is not intended to be a substitute for professional medical advice, diagnosis or treatment. The material is not intended to direct clinical care in any specific circumstance. The judgment regarding a particular clinical procedure or treatment plan must be made by a qualified physician in light of the clinical data presented by the patient and the diagnostic and treatment options available.

AtriCure

Table of Contents

Epi-Sense® ST™ Coagulation Device

Overview	1
Equipment Required	1
Product Description	1
Ablation Device	1
Coagulation Device Warnings and Precautions	2
Improper Device Positioning or Movement of Device During Power Application	4
Manipulation of Device with Cannula—Warnings	4
Cannula	4
Cannula Setup and Use	4
Cannula Use Warnings and Precautions	5
Potential Complications During Use of Cannula	5
Incorrect Manipulation of Cannula Guidewire	5
Posterior Wall Access Options	5
Temperature Probe Placement	5
Sub-Xiphoid Access	6
Cannula Placement and Manipulation	6
Endoscopic Visualization	7
Epicardial Lesion Creation	7
Electrogram Utilization with Epi-Sense ST Device	8
Posterior Left Atrial Lesions	8
Left Antral Lesions (Optional)	9
Right Antral Lesions (Optional)	10
Closing the Access Site	11
Procedure Tips	11
Sub-Xiphoid Access	11
Endoscopic Visualization	11
Cannula Manipulation	12
Epicardial Lesion Positioning	12
Esophageal Temperature Monitoring	12
Post-Epicardial Ablation—Pericardial Drain	12
Epicardial Lesion Creation	12
Device Attributes	13
Rationale for Decision to Re-Ablate a Lesion	13
Hybrid AF Convergent Therapy Recommended Anticoagulation Regimen	13

AtriClip PRO•V® Device LAA Exclusion System

Overview	15
Product Description	15
Equipment Required	15
Indications/Contraindications – PRO•V	15
AtriClip Device Warnings and Precautions	15
AtriClip Selection/Sizing	16
Articulation of End Effector	17
Clip Positioning	17
Deployment	17
AtriCure Procedural Overview	17
Recommended Anticoagulation Regimen	18
Best Practices for Stepwise Process of LAA Exclusion Procedure	18
References	20

AtriClip PRO2® Device LAA Exclusion System

Overview	21
Product Description	21
Equipment Required	21
Indications/Contraindications – PRO2	21
AtriClip Device Warnings and Precautions	22
AtriClip Selection/Sizing	22
Articulation of End Effector	23
Clip Positioning	23
Deployment	23
AtriCure Procedural Overview	24
Recommended Anticoagulation Regimen	24
Best Practices for Stepwise Process of LAA Exclusion Procedure	24
References	26

EPI-Sense ST Coagulation Device

Overview

Closed-chest access using the cannula allows the surgeon to access the atria through a small sub-xiphoid incision. The technology allows for the creation of long linear epicardial lesions that constitute the epicardial component of the Hybrid AF Convergent approach with no chest incisions, ports, lung deflation or heart dissections.

Creating a pericardial window permits access to the posterior surface of the heart for ablating cardiac tissue epicardially. Accessing the heart in this manner allows the EPI-Sense ST coagulation device to produce epicardial lesions without chest incisions.

A lesion can be created on the atria through the sub-xiphoid access. Figure 1 shows potential locations for the epicardial lesions.

Figure 1. Potential Epicardial Lesion Locations

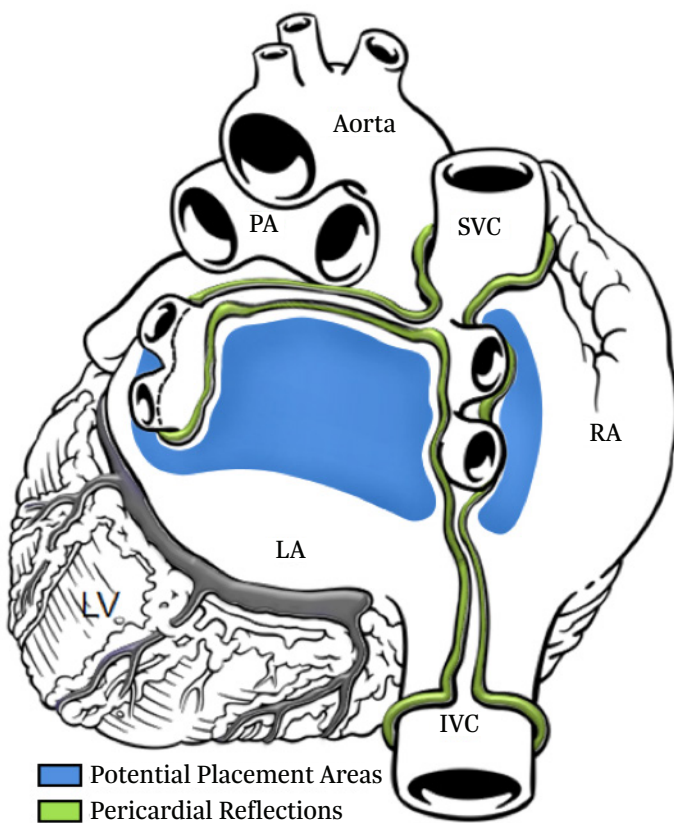

Equipment Required

- Only use 0.9% Normal Room Temperature Saline Solution (250 mL bag recommended)
- Sterile Perfusion/IV Tubing Set (10 Drops/mL)
- Sterile Vacuum Tubing Set
- Vacuum regulated to -400 mmHg (-533 mbar; -15.75 inHg; -40 cmHg; -7.73 psi; -400 torr; -53 kPa)

- 0.035" Guidewire 100 cm
- 5 mm Endoscope
- Temporary external electrogram recording device that meets the following specifications: Complies with IEC 60601-1 and system accepts shielded 2-mm pin connectors
- R2 pads

As with most endoscopic procedures, general anesthesia and its ancillary equipment are required.

An OR table with reverse Trendelenburg should be utilized.

To create the pericardial window, the following tools and equipment are recommended: video monitor, endoscopic camera, 0-degree 5-mm scope light source.

Once through the pericardium, the cannula permits visualization of the pericardial space and the placement of the EPI-Sense ST ablation device.

Product Description

Ablation Device

Figure 2 shows the bottom (2A) and side (2B) views of the ablation end of the device. As indicated, the **toe** is the distal portion, and the **heel** is the proximal portion of the ablation coil electrode. Eighty percent (80%) of the ablation coil is insulated with silicone, directing the radiofrequency (RF) energy into the targeted tissue. Figure 2A also shows the bipolar electrodes in between the RF coils. Figure 2B shows the arrows on the side of the device, indicating the direction of the exposed area of the ablating coil and RF energy. Figure 4 illustrates the integration of suction and perfusion into the exposed ablation coil region of the ablation device as well as illustrating the insulating silicone.

Figure 2. Bottom and Side View of 3-cm Device

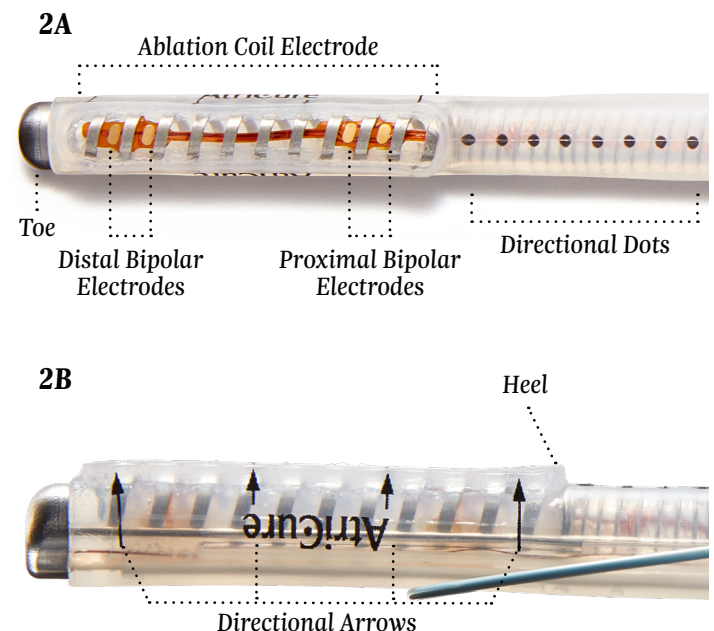

As a comparison, Figure 3 shows the ablation coil of the 3-cm device vs. a 3.5-mm 7Fr ablation catheter. Vacuum, integral to the device, is used to maintain contact between the Epi-Sense ST ablation coil and the epicardial heart tissue. The amount of power necessary to create a lesion is 30 W (3-cm devices).

Figure 3. Size Comparison 3-cm Device vs. 3.5-mm Catheter

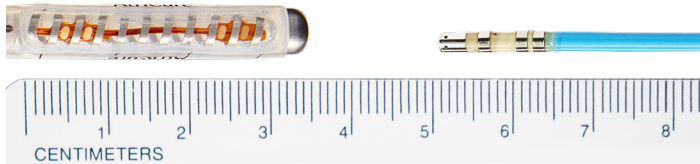
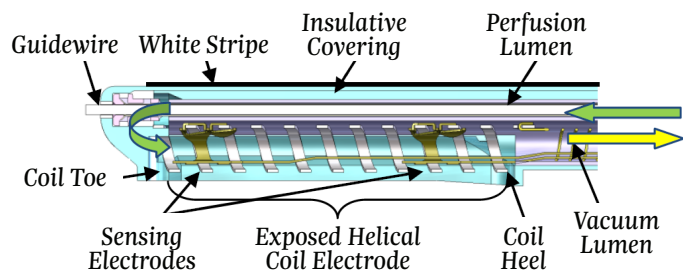

Figure 4. Active Electrode Site on the Device



Coagulation Device Warnings

- Care should be taken to ensure that the device is not in contact with tissue that is not going to be ablated (e.g. vascular and nerve tissue), in order to avoid inadvertent tissue damage.
- To avoid unintentional ablation, always ensure the device or device combined with optional guidewire is oriented toward the desired ablation location.
- Avoid contact with other surgical instruments, scopes, staples, or other objects while coagulating. Inadvertent contact with objects while coagulating could lead to conduction of RF energy or heat and unintentional ablation of tissues in contact with those objects.
- The device is provided sterile and is intended for single patient use only. Do not reprocess or reuse. Reuse can cause damage to device, patient injury, and/or the communication of infectious disease(s) from one patient to another.
- Do not scrape or scratch off the gold surface of the sensing electrodes when cleaning the RF ablation electrode to avoid an adverse reaction due to copper exposure to the patient.
- To avoid unintentional ablation, care should be taken to ensure overlapping structures are separated and thermally isolated when anatomy allows.
- Inspect all devices and packaging prior to use. If any breach of the packaging is found the sterility of the product cannot be ensured which poses a risk of patient injury. Do not use product if breach is found.

- The risk of igniting flammable gases or other materials is inherent in the application of RF energy. Precautions must be taken to restrict flammable materials from the area where tissue ablation is performed.
- Care should be taken to ensure device is not moved during RF power delivery. Device movement may cause loss of suction and tissue tear and/or unintentional ablation.
- Ensure overlapping structures are separated and thermally isolated when anatomy allows. If the overlapping structures cannot be separated and thermally isolated, ablation should not be performed.
- Care should be taken to ensure no vessels (or other structures) are restricted during device manipulation. Vessel restriction could cause hemodynamic instabilities or patient harm.
- Care should be taken to confirm device placement before power application to avoid collateral tissue damage.
- Care should be taken to fill distal end of cannula within the pericardial space with room temperature saline during ablation to avoid collateral tissue damage.
- Care should be taken to ensure device is perfused during ablation to avoid unintentional tissue damage.
- Physicians should implement a comprehensive anti-coagulation protocol including pre-operative, intra-operative and post-operative anticoagulation management to prevent potential thromboemboli.
- Physicians should use esophageal temperature monitoring as was conducted during the clinical investigation of the device to monitor for potential collateral tissue damage. Throughout the procedure ensure the temperature probe is located directly behind the ablation probe to ensure an accurate reading.
- Reuse of the ground pad utilized in the epicardial portion of the procedure for the endocardial portion may result in patient harm.
- Incorrect application of the ground pad during the procedure may result in lack of effectiveness.
- Simultaneous epicardial and endocardial mapping or ablation may result in cardiac injury.

Additional warnings and precautions can be found in the Coagulation System Radiofrequency (RF) Generator Unit Model CS-3000 Operators Manual).

Coagulation Device Precautions

- Precautionary measures should be taken prior to considering treatment of patients:
 - Deemed to be high risk and who may not tolerate a potential delayed post-procedure inflammatory pericardial effusion.

- Who may not be compliant with needed follow-ups to identify potential safety risks.
 - To ensure patients undergoing treatment with the EPI-Sense ST Coagulation Device device are well informed, the benefits, potential risks and procedural outcomes associated with the EPI-Sense ST Coagulation Device Hybrid Convergent procedure should be discussed with the patient. Physicians should document accordingly in the medical record.
 - Qualified operators are physicians authorized by their institution to perform surgical sub-xyphoid pericardial access.
 - Operators should complete training on the use of EPI-Sense ST Coagulation Device device before performing the procedure.
 - The coil on the distal end of the device must be kept clean of coagulum during surgery to avoid loss of power. Do not clean coagulum off the electrode of the device with an abrasive cleaner or electrosurgical tip cleaner. The electrodes could be damaged resulting in device failure.
 - Implantable cardioverter/defibrillators can be adversely affected by RF signals.
 - Interference produced by the operation of high-frequency surgical equipment may adversely affect the operation of other electronic medical equipment such as monitors and imaging systems. Rearrange monitoring device cables so they do not overlap the Coagulation System cables.
 - The use and proper placement of a ground pad is a key element in the safe and effective use of electrosurgery, particularly in the prevention of patient burns. Ensure entire area of electrode is reliably attached to the patient's body.
 - While the distal portion of the device is designed to conform to the anatomy of the area to be ablated, excessive manipulation, torqueing, rough shaping, or forcing the movement of the device may damage or deform the distal end and cause potential patient harm. This may also cause the sensing electrodes to become detached and or break off the device.
 - Care should be taken when handling the distal end of the device near the electrode with surgical instruments – do not squeeze or clamp the electrode. Do not cut or tear silicone.
 - The coagulation device is only compatible with the CS-3000 RF generator, cables, and accessories. Use of another manufacturer's accessories may cause damage to the device and/or injury to the patient.
 - Coagulation devices have pre-set power and time settings for optimal ablation. Changing these settings may cause ablation dimension to vary from the values given in this document.
 - Care should be taken to ensure the path to position the device is large enough to advance the device easily – forcing the device may damage the device, cause tissue damage or patient harm.
 - Care should be taken to ensure device is not twisted or over manipulated during procedure. Twisting/torqueing/over manipulating device can cause damage to the device, the lumen to collapse, loss of steering mechanism function, fracture of electrodes or vacuum lumen spring, separation of electrodes from device, kinking of PEEK guide tube, loss of suction, disconnection of perfusion/IV tubing, kinked perfusion/IV tubing, or patient harm.
 - Care should be taken to assure the ablation electrode is oriented towards the heart and away from the pericardium using visual cues, i.e. Reference Dots, Locator Arrows, and white stripe.
 - Connection of multiple devices to one vacuum unit may reduce vacuum functionality.
 - Care should be taken to ensure optional guidewire stays in the sterile field during manipulation.
 - Before ablation of tissue, ensure guidewire and/or scope are not between tissue and ablation device electrode.
 - If a guidewire is used with guided device, ensure that insulative covering is intact along the exposed guidewire.
 - The coagulation device should be used by physicians trained in the techniques of minimally invasive endoscopic surgical procedures and in the specific approach to be used.
 - If using a TEE probe, care should be taken to withdraw the TEE probe prior to ablation to avoid compressing the esophagus against the left atrium during ablation.
 - If the coagulation device is used near a pacemaker/AICD, a potential hazard exists due to possible interference with the action of the pacemaker and potential damage to the pacemaker. Consider placing a magnet on the pacemaker/AICD or programming the pacemaker/AICD per the manufacturer's instructions for use before applying RF energy.
 - Low battery will trigger the indicator light on the handle to YELLOW and stop the application of RF energy. Reference troubleshooting table in IFU.
 - High temperature of distal pod will trigger the indicator light on the handle to RED and stop the application of RF energy. Reference troubleshooting table in IFU.
 - RED light will appear if the device is not properly perfused with saline.
 - Safety and effectiveness of concomitant left atrial appendage closure was not evaluated in the CONVERGE study.
- Additional warnings and precautions can be found in the Coagulation System Radiofrequency (RF) Generator Unit Model CS-3000 Operators Manual).**

Closely monitor device positioning before and after power application to avoid collateral tissue damage.

- Ensure that the device is NOT in contact with vascular and nerve tissue.
- Ensure that overlapping structures are separated and thermally isolated when anatomy allows.
- Ensure that no vessels are restricted during device manipulation to avoid hemodynamic instabilities.
- Thin target tissue must be thermally isolated before application of power, such as the atrial appendage.
- The ablation device utilizes preset power and time settings; adjustment of these settings may result in excess or inadequate energy transmission.

Improper Device Positioning or Movement of Device During Power Application Can Result in:

- Power exposure to nontarget tissue; unintentional coagulation
- Inadequate coagulation depth
- Constriction of vessels
- Loss of suction

Manipulation of Device with Cannula—Warnings

- When inserting or retracting cannula from body, ablation device and guidewire should NOT be extended beyond tip of cannula.
- Before advancing device out of the cannula, ensure that the deployment path is large enough to avoid tissue damage.
- Excessive flexing and/or improper manipulation with surgical tools can result in:
 - Damage to device
 - Collapse of lumens
 - Fracture of electrodes or vacuum lumen spring
 - Separation of electrodes from device
 - Kinking of PEEK guide tube (rigid tube inside the guidewire lumen, within the ablation catheter)
 - Disconnection of tubing from handle
 - Breaking bond between PEEK guide tube and the distal end of the device

Cannula

The cannula is the conduit from the sub-xiphoid incision into the pericardial space, through which an endoscope and ablation device are introduced. The endoscope facilitates visualization of anatomy and positioning of the ablation device. Figure 5 indicates the top (5A) and side (5B) views of the distal end of the cannula.

Figure 5 shows the cannula used to facilitate the creation of atrial lesions. The cannula is supplied as either a 30-cm or 40-cm length device. The inner diameter of the cannula is 0.65 in.

Figure 5 also designates specific nomenclature describing the cannula. The cleft is the small opening which faces the atrium and improves working visibility. The tip is the farthest point on the bevel end of the cannula. This should face the pericardium during the procedure.

Figure 5. Top and Side View of the Cannula

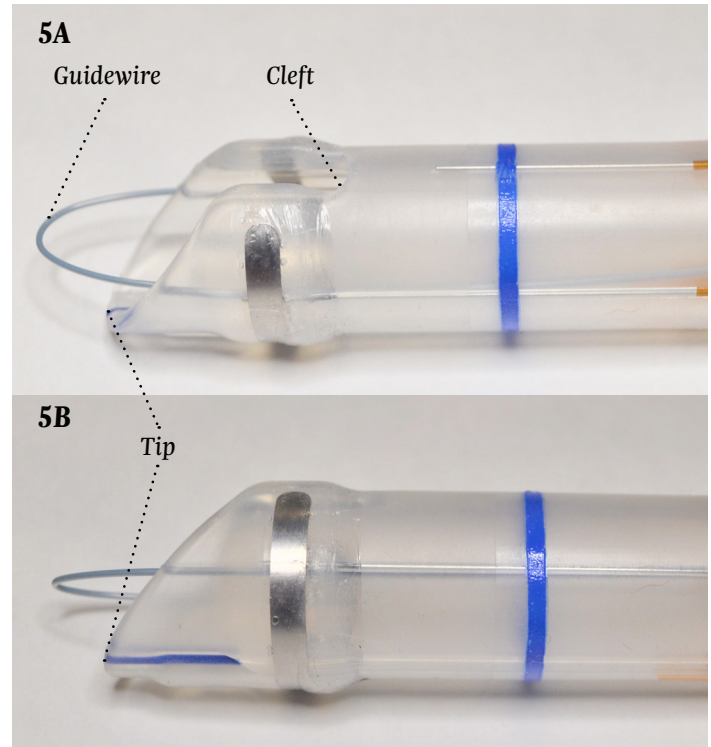
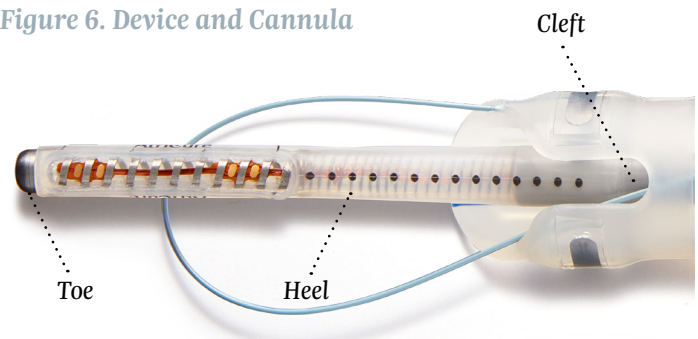

Figure 6 shows the relative position between the device and the cannula.

Figure 6. Device and Cannula



Cannula Setup and Use

- Manipulation of Guided Coagulation Device Over Cannula Guidewire – Optional
- If using cannula guidewire, place cannula guidewire in desired coagulation location.
- If attached, remove torquer from end of guidewire.
- Carefully feed one end of the guidewire into the guide tube in the distal end of guided coagulation device.
- Slide guided coagulation device until guidewire protrudes from handle of guided coagulation device. If available, attach torquer to the end of guidewire protruding from handle of device.

- Advance the guided coagulation device along the guidewire until positioned at desired coagulation location using guidewire to assist in placement.

Cannula Use Warnings

- The cannula is provided sterile and is intended for single use only. Do not reprocess or reuse. Reuse can cause patient injury and/or the communication of infectious disease(s) from one patient to another.
- Inspect the device packaging prior to use. If any breach of the packaging is found, the sterility of the product cannot be assured, and the product should not be used.

Cannula Use Precautions

- Endoscopic procedures should be performed only by physicians with adequate training in endoscopic techniques.
- Inspect the cannula and guidewire prior to use. Ensure that cannula distal end and guidewire are smooth with no sharp edges. Sharp edge can cause potential patient harm. If sharp edge is found, device should not be used.
- Avoid over-rotating the cannula. Over-rotation can cause the vacuum tubing of the cannula to kink, reducing the cannula suction, thus causing reduced visibility.
- Care should be taken when inserting the cannula. Applying excess force could cause potential patient harm. To reduce friction during insertion, lubricate the cannula with sterile saline.
- Care should be taken when manipulating the guidewire. Always ensure no tissue is caught by the guidewire and brought into the cannula lumen.
- Care should be taken when manipulating the guidewire. Excessive force may damage the cannula and/or guidewire.
- Avoid over-inserting the cannula into patient. Over insertion may reduce cannula suction.
- Avoid excessive pulling on the torquer. Excessive pulling on torquer may damage the cannula and/or guidewire.

Potential Complications During Use of Cannula

- Blunt trauma to adjacent organs
- Pericardial effusion
- Vessel injury
- Tissue perforation
- Hemodynamic instabilities
- Arrhythmias
- Thromboembolic complication
- Pneumothorax
- Infection

Incorrect Manipulation of Cannula Guidewire

Applying excessive force while pulling on guidewire could damage distal end of cannula and break guidewire.

Posterior Wall Access Options

Temperature Probe Placement (Figure 7)

Ablations should be performed with continuous esophageal temperature monitoring. The probe placement may be confirmed in one of the following ways:

- **Probe Placement Option 1:** After the cannula is inserted into the pericardium, fluoroscopy can be obtained prior to ablation. Metallic aspects of the cannula and ablation device clearly delineate the appropriate level.
- **Probe Placement Option 2:** After removing the TEE probe, the temperature probe is placed in the esophagus and placement is confirmed by fluoroscopy prior to patient skin preparation. The probe should be placed approximately 1½ to 2 vertebral bodies caudal to the bronchial carina. This also corresponds with the bulge of the atria of the cardiac silhouette.

Figure 7. Temperature Probe Placement

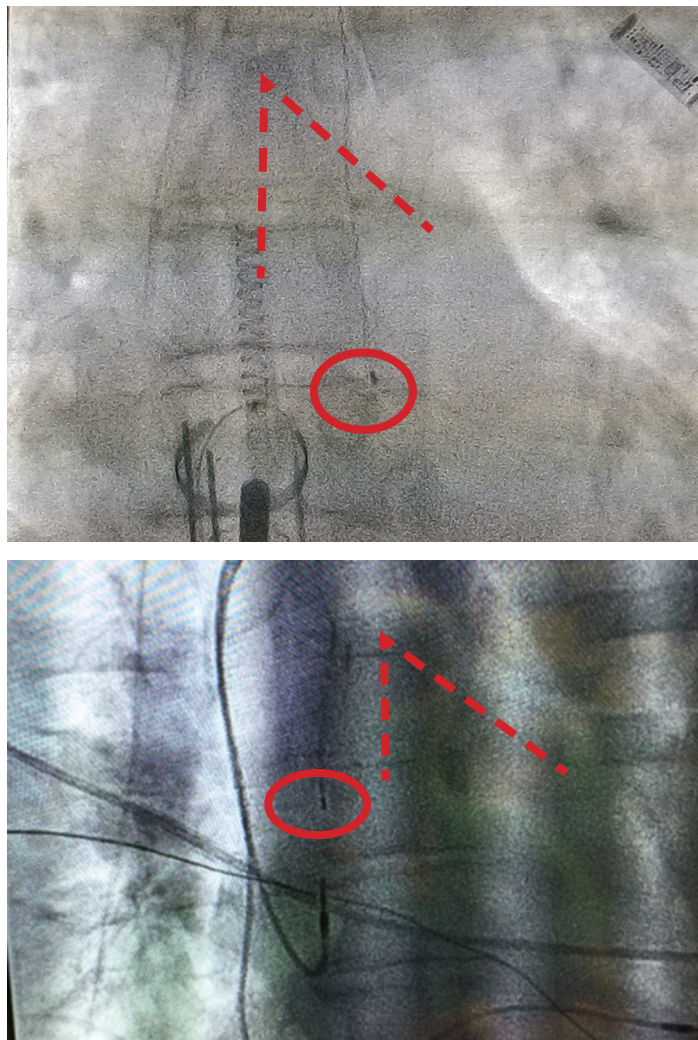

*Souba, W. W. (©2007). *Acs Surgery: Principles and Practice* (6th ed., p. 1). New York, NY: WebMD Professional Pub.

Sub-Xiphoid Access

A small vertical incision is made from the xiphisternal junction downward to a point slightly below the tip of the xiphoid process (see Figure 8). The upper extent of the linea alba is divided, with care taken not to enter the peritoneum. Peritoneal openings are easily repaired but can make the procedure technically more difficult, in that abdominal contents tend to impede visualization, especially in spontaneously breathing patients. The soft tissue attachments to the xiphoid are divided, the veins running along either side of the xiphoid are controlled, and the xiphoid process may be removed. Coagulation may be used when creating the pericardial window to ensure hemostasis of the microvasculature. Caution must be exercised when using coagulation to ensure that no damage is done to the underlying heart, and no ectopy is induced. The tissue plane behind the lower sternum is developed by means of blunt dissection. This maneuver exposes the retrosternal space to allow visualization of the pericardium. To enhance exposure, the sternum may be retracted upward by an assistant. The anterior pericardial surface is then exposed by sweeping away the remaining mediastinal fat. If necessary, the confluence of the pericardium and the diaphragm may be retracted caudally to improve exposure.

The location of the pericardial incision can be confirmed by palpating cardiac motion through the exposed pericardium. The pericardium is then opened with the energy source of choice; shallow strokes should be employed to reduce the chances of injury to the underlying myocardium that may be adherent to the pericardium. Upon entry into the pericardium, there is an initial outrush of fluid. A sanguineous effusion can be difficult to differentiate from cardiac injury; therefore, the patient's hemodynamics should be carefully monitored during this time. When the pressure placed on the heart by effusion is released, blood pressure will usually rise and heart rate fall. However, if the heart has been accidentally injured, administration of a diuretic (e.g., furosemide) should be considered to reduce the risk of pulmonary edema developing as a result of systemic fluid retention.

Figure 8. Sub-Xiphoid Pericardial Window

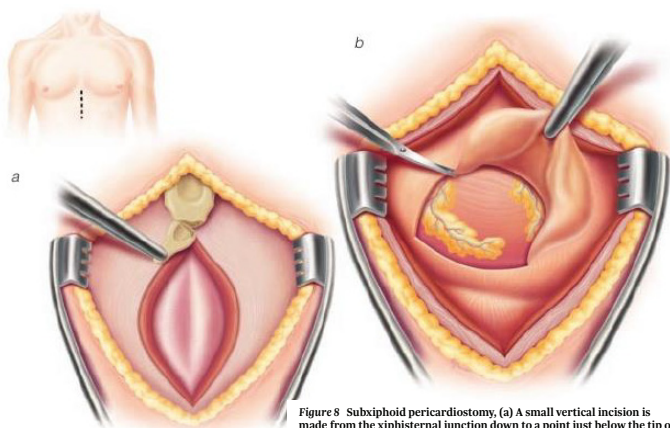
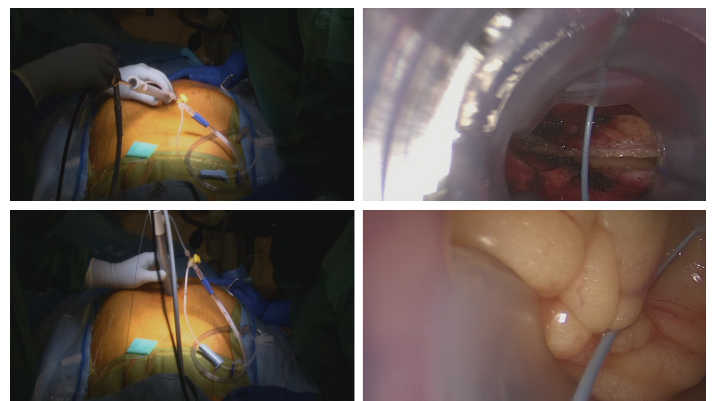

Figure 8 Subxiphoid pericardiostomy. (a) A small vertical incision is made from the xiphisternal junction down to a point slightly below the tip of the xiphoid, the upper extent of the linea alba is divided, and the xiphoid is removed. (b) The pericardium is opened, and the edge of the opening is grasped and elevated. A pericardial specimen several square centimeters in size is then resected to create the pericardial window.

The opening in the pericardium is enlarged by finger dissection until it is approximately 7 cm in width, large enough to allow passage of the cannula. The cannula is inserted with the endoscope inside the cannula providing visualization. The incision in the pericardium should be visualized through the cannula as seen in Figure 9; the cannula should then be positioned to nearly vertical (see Figure 9) and inserted into the pericardial space. Ensure appropriate visualization of the diaphragmatic aspect of the pericardium. Position the cannula so the tip of the cannula is against the pericardium and away from the IVC. Insert the cannula, following the pericardium around the RV to the posterior of the heart and the posterior left atrium. In this location the cannula angle will be closer to 45 degrees and there might be pressure on the ventricle.

Figure 9. Sub-Xiphoid Cannula Insertion



Arterial blood pressure should be monitored throughout the procedure. Volume administration to increase blood pressure should be monitored to limit the potential for dilatation of the right atrium.

Cannula Placement and Manipulation

The cannula should be positioned through the incision and into the pericardial space. Positioning the tip of the cannula at approximately 12 o'clock, cleft at 6 o'clock, rotate the cannula clockwise 180 degrees (Figure 10) to separate the heart from the pericardium and provide space through which the cannula can be inserted (Figure 11). As the cannula is advanced into the pericardial space, it should be directed towards the patient's left, away from the IVC.

Do not connect the cannula vacuum port to suction until after placing the cannula through the pericardial window, otherwise tissue inside the pericardium will be pulled into the distal vacuum holes and clog the vacuum lumen.

Figure 10. Cannula Tip at Pericardial Window

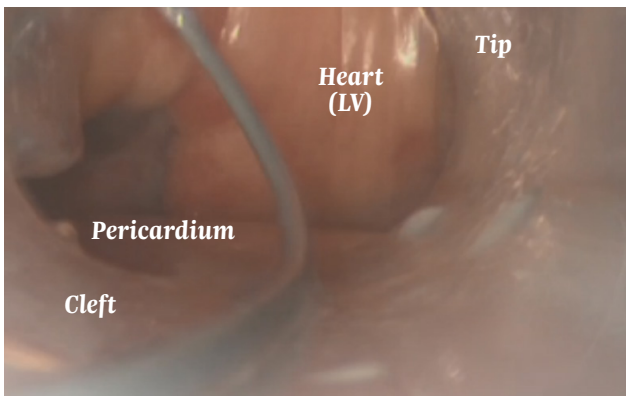
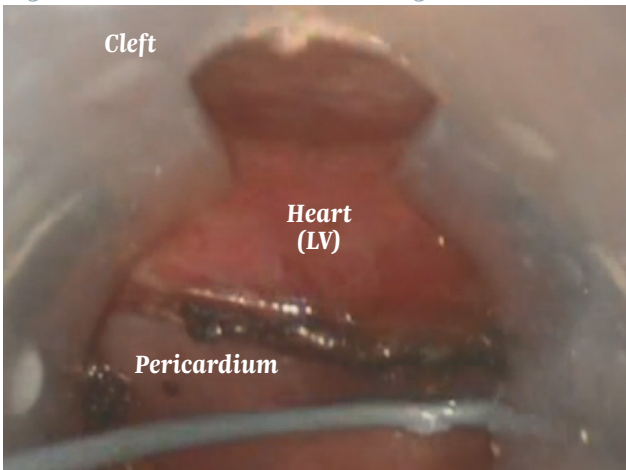

Figure 11. Cannula Rotated Through Incision



Endoscopic Visualization

Use the cannula to create space so that an endoscope can provide direct visualization of the posterior left atria. When the pericardium is intact and free of adhesions, the cannula will gently separate the heart from the pericardium and create a cavity into which the device may be advanced under endoscopic visualization.

The cannula may be manipulated along the posterior heart surface to visualize the left pulmonary veins (LPV) (Figure 12A), the right pulmonary veins (RPV) (Figure 12B), the inferior vena cava (IVC), the coronary sinus (CS), and the posterior left ventricle (LV). To manipulate the cannula, use the bevel end to lift the heart. Rotate the cannula during manipulations to separate the heart from the pericardium and facilitate delineation of anatomic structures. Use the cleft to visualize tissue structures and assist in creating space. It is best to have the tip of the cannula against the pericardium as opposed to the heart surface.

Figure 12A. Posterior View of Inferior Near LPV

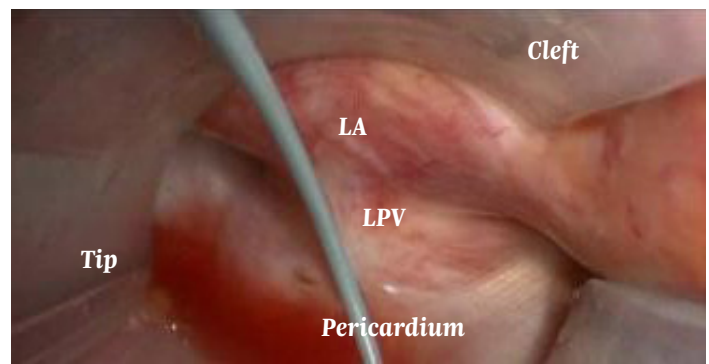
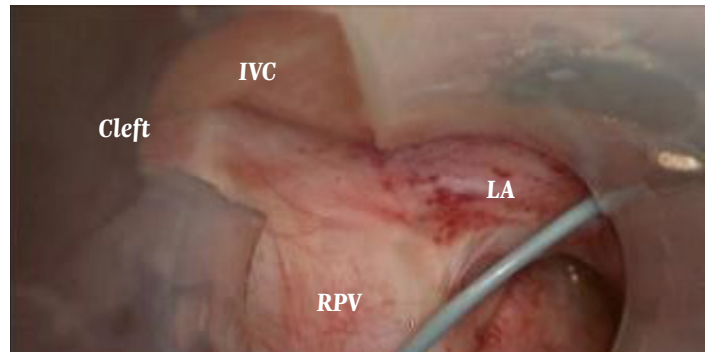

Figure 12B. Posterior View of Inferior Near RPV



Epicardial Lesion Creation

Prior to creating any lesions, be sure to remove the TEE probe and the NG/OG tube (if used), or at the very least pull far back relative to the esophagus, so that the probe is nowhere near the atrium.

The upper alarm limit of the temperature probe should be set to 38.0°C. The preset power and time settings for ablation with the coagulation device are based on extensive testing; changing the settings may cause excessive heating and tissue damage. Prior to ablation, connect a stopcock in-line between the vacuum port and the tapered adaptor to control vacuum through the cannula. During ablation, room temperature saline should be administered through the cannula to cool and hydrate the pericardium and underlying anatomy. Before injecting the saline, turn the cannula vacuum off by closing the in-line stopcock.

If the esophageal temperature increases to either >38.0°C, or 0.5°C over baseline,* RF energy delivery should be stopped until the temperature returns to <37°C or to baseline.

**Note: Baseline temperature should be taken prior to any lesion creation.*

Electrogram Utilization with Epi-Sense ST Device

The two bipolar sensing electrodes embedded in the Epi-Sense ST device may be connected to an electrophysiology (EP) workstation or ECG recorder to visualize the electrical signals of the tissue to which the device is suctioned. Figure 13 illustrates the ECG signals as measured with an Epi-Sense ST device. In this figure the amplitude of the electrical signal can be seen to demonstrate the difference between having the device suctioned to pericardium versus epicardium. Positioning of the Epi-Sense ST device should be determined based on direct visualization through the endoscope; the ECG signals from the Epi-Sense ST device should be used to confirm direct visibility. The device should be fully suctioned to the desired tissue prior to reviewing the ECG signals.

Figure 13. Electrogram Recording: Pericardium vs. Epicardium

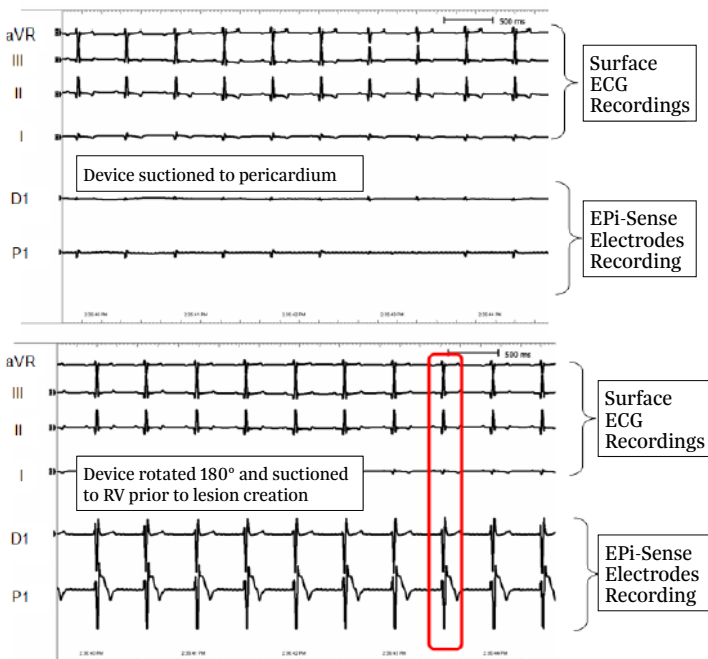

The ECG signals may also be utilized to verify the coagulation of the tissue during lesion creation. As the tissue is coagulated during the lesion creation process the ECG amplitude will decrease.

Electrophysiologists follow this process of observing ECG amplitude decrement to determine lesion completeness, typically relying on a 90% decrement to correspond to a complete lesion. Figure 14 illustrates the decrement of amplitude as measured by an Epi-Sense ST device before and after the creation of an atrial lesion.

Figure 14. Electrogram Recording: Pre- and Post-Ablation

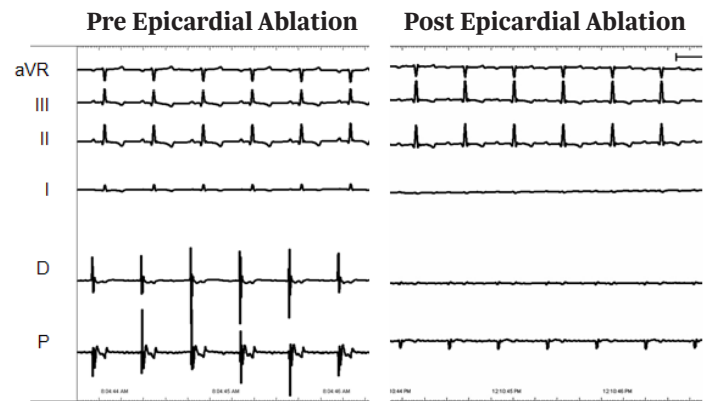

Posterior Left Atrial Lesions

To achieve more desired lesion locations, the physician will determine the best device deployment method. This training guide gives examples of different approaches to deploy the device (Figure 15).

Figure 15. Posterior Left Atrial Lesions

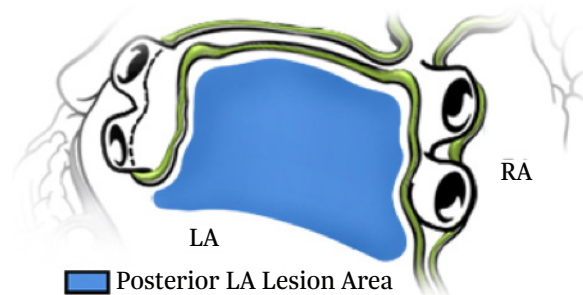

To create lesions along the posterior left atrium, parallel to the RPVs or the LPVs, position the cannula under the left atrium. Once in the proper location, use the cannula to separate the pericardium to create space and allow visualization of the posterior anatomy. This is achieved with the tip of the cannula facing the pericardium (cleft facing the heart). This maneuver will create a space for the device (Figure 16). Once the cannula is at the desired location, advance the device such that the ablating coil is in the appropriate location, with coils facing the heart (Figure 17A).

Retract the cannula while maintaining the device placement. This will allow the heart to better sit against the device. Always ensure proper orientation of the exposed ablation coil electrode under endoscopic visualization, utilizing the directional arrows and white stripe on the back of the device to confirm contact with atrial tissue only (Figure 17B).

Figure 16. Lateral View of Device

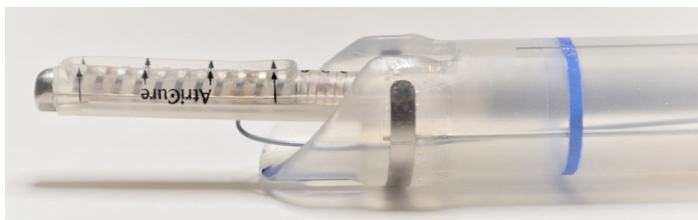

Ablation Device—RF Coil Facing Left Atrium (Arrow Direction)

Figure 17A. Positioning the Device and Cannula in the Desired Location

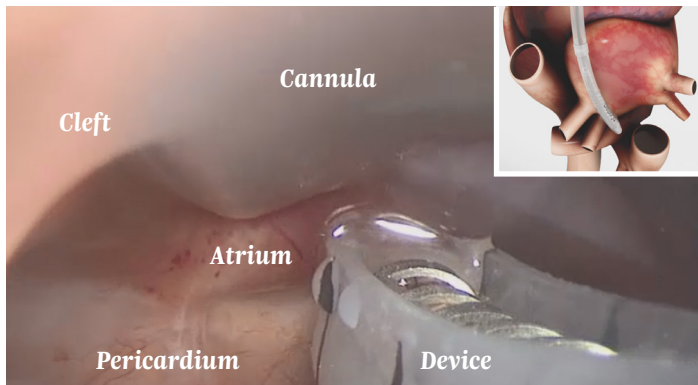
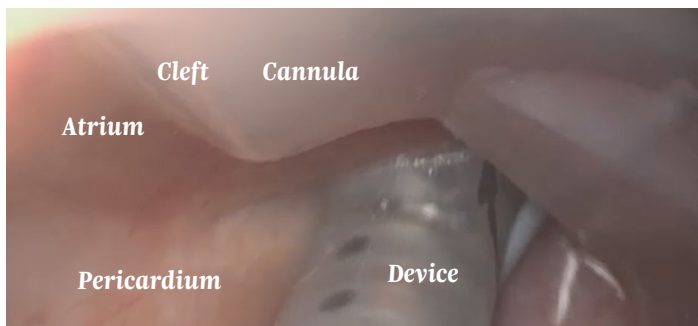

Figure 17B. Retracting the Cannula While Maintaining the Device Position



Continue to manipulate the cannula and device such that lesions on the posterior LA are adjacent to one another. Repeat lesions until ablation of posterior LA is complete.

To avoid deformation of the pericardial reflections or the ablation device and the misdirection of RF energy delivery, do not use excessive force when advancing the device against the reflections, and slightly pull back on the cannula to retract the deployed device from the reflections.

Multiple applications of RF energy may be required to create the desired posterior left atrial lesion, with the 3-cm device. Always confirm that the ablation coil arrows are directed toward the heart, away from the pericardium.

Epicardial lesions are visible and connection of discrete lesions provides confirmation of lesion continuity. Use the endoscope to facilitate manipulation of the cannula when confirming that the lesions intersect.

Left Antral Lesions (Optional)

Deflectable steering provides additional control for placement of the ablation coil at the desired tissue location. To position the device along the anterior LPV (Figure 18), orient the cannula around the inferior LPV such that direct access to the anterior surface is obtained. To locate this area, position the cannula around the LPVs, locate the inferior LPV with the cannula, rotate the tip to 2 o'clock, and use the endoscope to assist the cannula around the LPVs. Once in position, gently rotate the cannula clockwise to create space between the left atrium and the pericardium.

When the desired cannula location is obtained, advance the device such that it passes anterior to the superior LPV and the exposed side of the RF coil (arrows pointing towards the left atrium) faces the left atrium. Remember that in most cases, the superior LPV is anterior to the inferior LPV. Deflectable steering provides additional control for placement of the ablation coil at the desired tissue location. Use caution when advancing the device, do not exert excessive force. Engage the vacuum and retract the cannula (Figure 19).

Figure 18. Left Antral Lesions

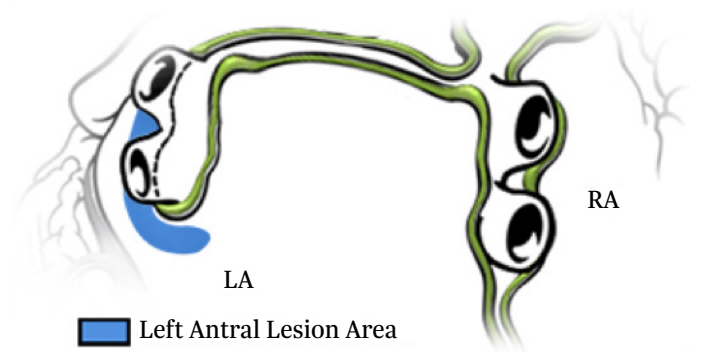
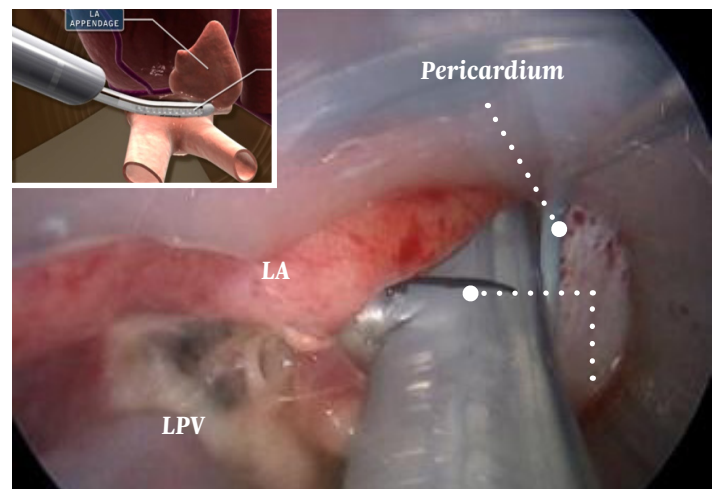
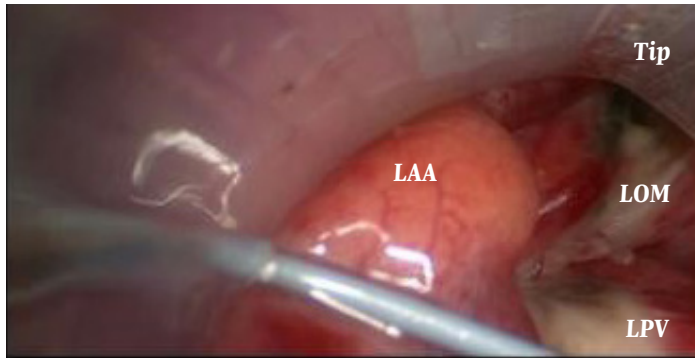

Figure 19. Left Antral Device Placement



This region may provide access to the ligament of Marshall (LOM), the left atrial appendage (LAA), the transverse sinus and the anterior portion of the LPV (Figure 20).

Figure 20. Ligament of Marshall Lesion



Right Antral Lesions (Optional)

The anterior right atrium (Figure 21) can be accessed by rotating the cannula over the IVC. To position the cannula over the IVC, place it adjacent to the IVC from the posterior left atrium (cleft directed towards 10 o'clock) to visualize the IVC. Retract the cannula to identify the opening around the IVC, with visible confirmation of the IVC, right atrium, and pericardium. As the tip of the cannula (which extends beyond the cleft) is retracted past the IVC, it may be rotated counterclockwise, orienting the tip to 9 o'clock, and positioned between the right atrium and the pericardium. The cannula may be used to create space to assist in identifying the anterior RPVs.

With the cannula positioned over the IVC, the ablation device may be advanced such that the coagulation electrode is located along the anterior orifice, between the RPV antrum and the right atrium. The cannula may be used to create space between the pericardium and the atria, allowing the coagulation electrode to sit against tissue. The cannula also helps separate the pericardium (and phrenic nerve) from the atrium, permitting the ablation device to be positioned along the Waterston's groove region that defines the interatrial junction. Continue to utilize the agility of the Epi-Sense ST's steering lever for ideal lesion creation. A lesion may be created at the left orifice to the RPV antrum.

Figure 21. Right Antral Lesions

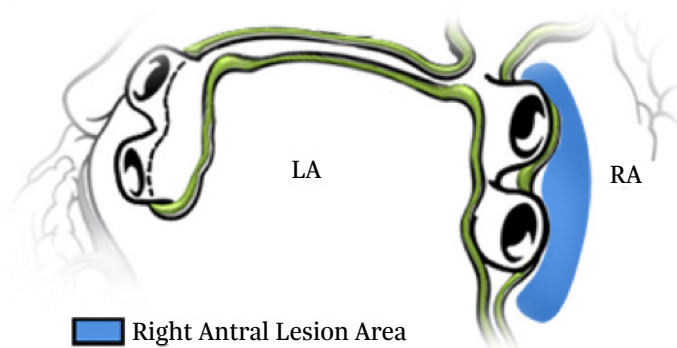

Before creating lesions along the anterior RPV antrum, identify landmarks such as the SVC and the superior and inferior branches of the RPV (Figure 22). Some atria incorporate a long common antrum with the inferior and superior branches bifurcating at the level of or after the pericardium.

Figure 22. Visualizing Waterston's Groove

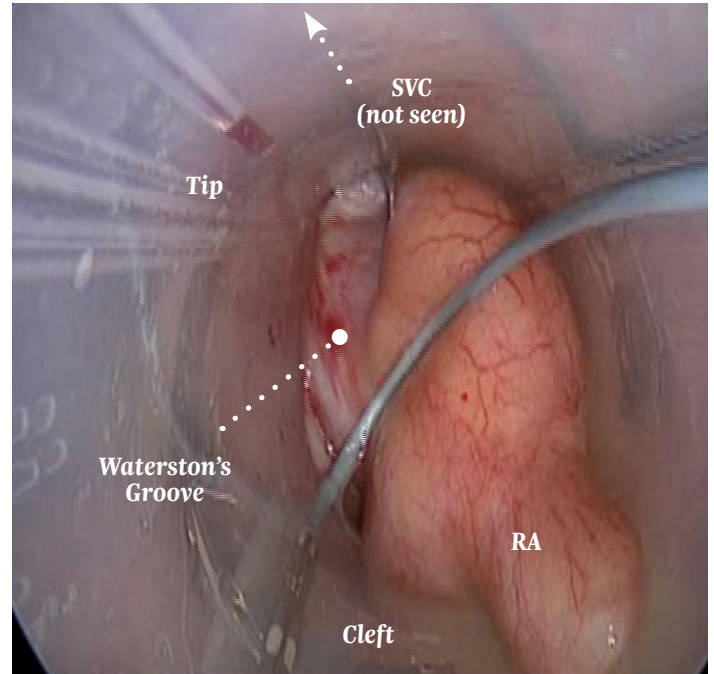

When positioning the ablation device along the RPV antrum 'off the cannula guidewire,' identify the RPVs and SVC, and position the device with the arrows directed towards 4 o'clock. The exposed electrode should be oriented parallel to the interatrial groove with the toe of the device along the RPV antrum, under the SVC, and adjacent the superior RPV branch (Figure 23). Ensure the heel lip contacts atrial tissue at the level of the orifice, between the RPV antrum and the left atrium.

Figure 23. Right Antral Placement

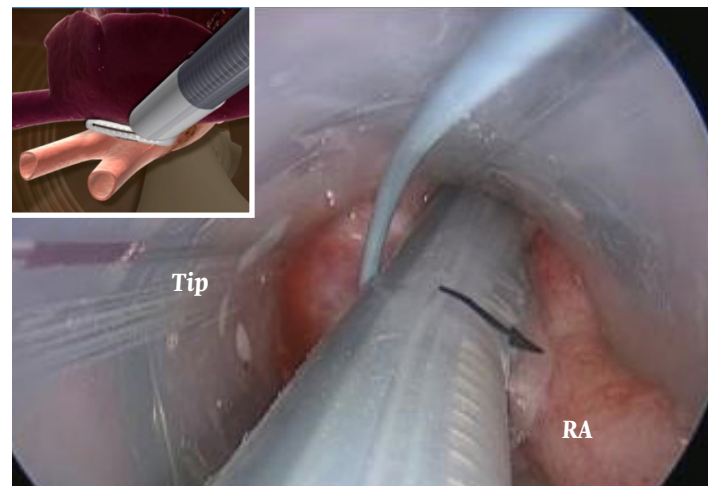

When positioning the ablation device—especially when targeting the inferior RPV region—orient the cannula

with the tip against the pericardium and the cleft facing the left atrium. Identify the RPVs and advance the ablation device such that the exposed side of the RF coil (direction of arrows) faces the left atrium. The RF coil should run parallel to the RPV orifice. Avoid applying excess force against the pericardium or over advancing the cannula or ablation device.

Closing the Access Site

After the creation of all desired epicardial lesions, insert a pericardial drain (19 to 24 Fr Blakemore or JP Drain) through the cannula and position it through the pericardial window and under the posterior surface of the heart (Figure 24). The fluted end of the drain may be cut to ensure that the drainage portion is in the pericardium, not in the epicardial space.

Figure 24. Place Pericardial Drain Under Heart



Once the drain is inserted into the pericardial space and positioned under the left atrium, the cannula may be slowly retracted under endoscopic visualization.

Properly positioned, the vacuum ports of the pericardial drain should reside within the pericardium (Figure 25). This should be confirmed prior to retracting the cannula from the abdomen.

Figure 25. Ensure Drain Is in the Pericardial Space

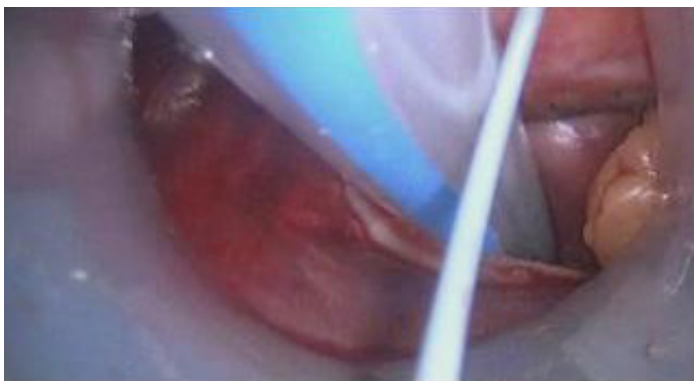

The free end of the drain should be fully advanced through the cannula, as the cannula is completely retracted from the incision. The free end of the drain may then be pulled through a peripheral drain-outlet incision with the help of a chest tube clamp or another surgical grasper.

Procedure Tips

Sub-Xiphoid Access

- Initial incision should be longitudinal (approximately 3 cm in length) directly over the xiphoid process.
- Divide the linea alba with electrocautery.
- Surgeon may elect to remove some—or all—of the xiphoid process to aid in visualization and cannula access.
- Using a combination of sharp and blunt dissection, expose the pericardium.
- Make a transverse pericardiotomy just over the diaphragm approximately 7 cm in length.
- One may extend the pericardiotomy vertically in the midline approximately 1.5 cm if desired.
- With tip rotated to 12 o'clock, introduce cannula into the incision and gently advance towards the pericardiotomy. Do not connect suction to cannula until the cannula is determined to be in the oblique sinus.
- Once the tip of the cannula is inside the pericardium, and trending behind the heart, introduce the scope into the cannula.
- Gradually rotate the cannula clockwise 180 degrees while slowly—and gently—advancing the cannula behind the left atrium.
- The cannula tip should now be at 6 o'clock pointing towards the pericardium (and away from the heart).
- While advancing the cannula, bias slightly towards patient's left (to avoid contact with the inferior vena cava).

Endoscopic Visualization

- When visualizing the posterior heart surface, standard landmarks must be identified. The right and left pulmonary veins, the inferior vena cava, and the coronary sinus define the working region along the posterior atria where devices are positioned, and lesions may be created.
- Right is left and left is right. When moving the view to the posterior heart surface, images from the endoscope are reversed. The right pulmonary vein and inferior vena cava are located on the left side of the viewing screen and the left pulmonary vein is located on the right side of the screen.
- Use the suction feature of the cannula to keep the field dry. Any fluid contacting the scope will cloud the field of view and require removing the scope for cleaning.

Cannula Manipulation

- Rotating the cannula facilitates gross and fine movements between the heart and the pericardium. All cannula movements should be accompanied by rotation.
- Use the bevel tip and cleft of the cannula when advancing and rotating the cannula, to facilitate separation of the heart from the pericardium and to create a cavity to visualize the posterior heart.
- A 5-mm scope is used inside the cannula to initially position the cannula at the desired location within the pericardium. The stiffness of the scope facilitates the movement of the cannula along the posterior or lateral heart.
- Ensure the cannula tip does not push into anatomic structures. The tip extends beyond the cleft of the cannula and care should be taken to recognize the location of the tip while manipulating the cannula.

Epicardial Lesion Positioning

- When manipulating the ablation device through the cannula, use a 5-mm scope to provide enough room for both the scope and the guided device.
- Use the steering lever to deflect the tip of the device over the guide wire.
- Before advancing the ablation device into contact with the heart, ensure that the arrows indicating the direction of the RF coil are oriented such that the device electrode contacts epicardial tissue, not the pericardium.
- The handle has an adjustable tension control knob that allows the operator to adjust friction to where the steering lever and tip curve can be locked in place when the desired device placement is achieved.
- The amount of tension increases as the tension control knob is rotated clockwise until it reaches the full 'locked' position. Counter rotation from the 'locked' position decreases the friction.
- If necessary, to improve the vacuum seal of the device to the atrium, slightly retract the cannula so the atrium sits onto the coagulation electrode.
- With the cleft of the cannula facing up, the guided device sits with the toe towards to the right side of the cannula, where the guidewire is affixed. To reverse the orientation so the toe is facing left, rotate the cannula 180 degrees. The tip will now be at 12 o'clock and the cleft at 6 o'clock. To confirm proper orientation, observe the printed arrows on the side of the device are pointing towards the epicardium.

Esophageal Temperature Monitoring

- **Temperature in the esophagus should be measured throughout the ablation procedure.**
- **Fluoroscopy should be used to position the esophageal temperature probe behind the heart and adjacent to the left atrium.**

- **If esophageal temperature exceeds 38°C, or more than 0.5°C from the baseline temperature, RF energy delivery should be discontinued until the esophageal temperature returns to baseline.**
- **Saline may be injected through the cannula to reduce temperature in the pericardial space prophylactically or upon observation of esophageal temperature rise.**

Post-Epicardial Ablation—Pericardial Drain

- A drain should be placed through the pericardial window to remove excess fluid during the immediate post-operative period.
- A 19 to 24 Fr Blakemore or JP Drain may be used. Hydroglide drains are also effective and easy to place.

Epicardial Lesion Creation

Creating an RF ablation lesion requires a complete electrical circuit. The coagulation system requires the following elements to complete the circuit (Figure 26):

1. An RF generator to produce the electrosurgical current
2. Cables (insulated) to connect active electrodes to generator
3. Electrode to deliver RF current to coagulate target tissue
4. A patient to receive the energy
5. A grounding pad with cord to complete the circuit and return energy back to generator safely

Figure 26. Electrical Circuit for RF Energy

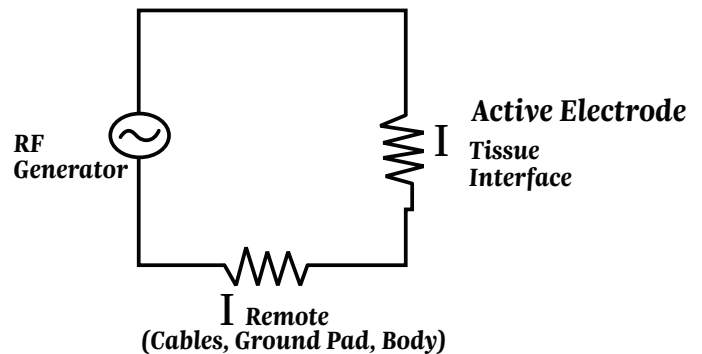

The body will act as a conductor of RF energy. The tissue under the grounding pad will have minimal heating due to the difference in surface area between the active electrode (1.048 cm²) and the grounding pad (137 cm²).

The lesion is created by using alternating current (about 480 kHz) which passes from the RF electrode to the tissue. The alternating current causes ionic vibration as ions attempt to follow the change in direction of the alternating current. The heat is created by the friction of the vibrating ions, not the electrode probe. With a higher current, the more vigorously the ions move, and thus the higher the temperature. The goal of RF ablations is to achieve local temperatures such that tissue coagulation occurs, not vaporization.

Reversible thermal injury to cells begins as 42°C. Immediate tissue coagulation will occur as the temperature moves above 60°C. The “sweet spot” for RF ablation is 50° to 90°C. This will induce irreversible block and reduction of microvasculature perfusion without overheating tissue.

Device Attributes

The suction capabilities of the Epi-Sense ST allow consistent tissue contact with the RF coils. This creates consistent energy transmission and complete transmural lesions without gaps.

The posterior of the coagulation device (opposite the RF coil) is cooled via saline solution. This solution constantly circulates through the device as suction is applied. This cooling perfusion prevents thermal spread and keeps the posterior of the device cool.

Rationale for Decision to Re-Ablate a Lesion

This may be from any one or a combination of following:

1. Observation of anatomy/fat underneath device
2. Visual inspection of lesion for non-continuous surface discoloration
3. Interrogate the electrograms from the Epi-Sense ST device
4. Notation of impedance decrease of > 10%

Using the above rationale to decide to re-ablate a lesion can improve the success of delivering the appropriate amount of RF energy to the tissue.

Hybrid AF Convergent Therapy* Recommended Anticoagulation Regimen: Epicardial Pre, Intra and Post Procedure Treatment

Pre-Procedural

Antiarrhythmic regimen | Anticoagulants

- Continue antiarrhythmic regiment (e.g. Tikosyn vs Amiodarone)
- Consider rate control medications (e.g. Diltizem vs Metoprolol)
- Discontinue Pre-surgical DOAC 24 hrs prior to first incision
- If discontinuing Pre-surgical DOAC > 24 hrs prior to first incision, consider bridging with Lovenox, Heparin if patient:
 - Is at increased risk of LA thrombus/history of LAA thrombus
 - Has an elevated CHADSVASC > 4
 - History of TIA/CVA
- Minimize time between discontinuation of DOACs and first incision
- Patient thrombogenicity increases
- Watch for thrombus

Intra-Procedural

- Heparinization during epicardial ablation w/ Epi-Sense and Epi-Sense ST™ ACT > 300 prior to ablating
- During endocardial catheter ablation -per anticoagulation protocol consistent with HRS guidelines¹
- Recognize window of minimal protection between loss of heparin effectiveness and DOAC effective therapeutic range

Post-Procedural

Post-Op anticoagulation management

- Develop strategy with EP and combine with Post-surgery anticoagulation therapy
- Follow 2017 HRS Expert Consensus for anticoagulation management post ablation¹
- Immediately following transfer to unit activate anticoagulation and before ACT reaches normal (100-125) when patient is at highest risk of thrombi
- Consider resuming DOACs (every DOAC has a different therapeutic time) within 4-6 hours post-procedure if there is no bleeding

*When using Epi-Sense/Epi-Sense ST

1. Heart Rhythm, Vol 14, No 10, October 2017

AtriClip PRO•V LAA Exclusion System

Overview

Minimally invasive thoracic surgery, utilizing a video-assisted thoracoscopic approach, requires three to four incisions to place ports into the requisite intercostal spaces. The AtriClip PRO•V allows for closed chest LAA (left atrial appendage) exclusion and subsequent LAA electrical isolation from the left atrium.

Port placement in the lateral left chest wall allows access to the pericardium for creation of pericardiotomy and LAA ligation. Accessing the heart in this manner permits the surgeon to gain entrance to the pericardium and place an AtriClip device at the base of the LAA, in the absence of an open sternotomy procedure.

Product Description

The AtriClip LAA Exclusion System contains the PRO•V Clip for exclusion of the heart's left atrial appendage (LAA). Preclinical animal studies (Kamohara 2005, 2006) demonstrate that complete exclusion with the Clip also results in acute and chronic electrical isolation of the LAA. A human clinical study (Starck 2012) has demonstrated acute electrical isolation. Chronic electrical isolation has not been evaluated in human clinical studies.

The Clip is pre-loaded on a disposable Clip applicator. The AtriClip LAA Exclusion System with preloaded PRO•V Clip does not contain natural rubber latex components.

The AtriClip LAA Exclusion Device features Active Articulation Levers, Articulation Lock, Ambidextrous Lever/Release Trigger, Vertical/Lateral Movement, Rigid Shaft and quick release Deployment Tab for Exclusion Device placement.

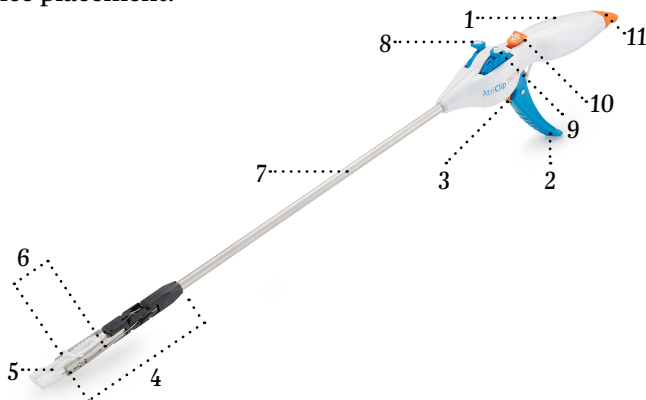

1	Handle	7	Shaft
2	Activation Lever	8	Up/Down Articulation
3	Lever Release Trigger	9	Left/Right Articulation
4	End Effector	10	Articulation Lock
5	PRO•V Clip	11	Deployment Tab
6	Clip Opening Jaws		

Equipment Required

Additional supplies will be necessary when the VATS LAA ligation procedure is performed concomitantly with the Hybrid AF Convergent procedure.

- A 30° 5 mm scope for visualization with insufflation tubing, (3x) 5 mm ports and (1x) 12 mm port for chest access. Endoscopic Kittners, suction irrigator, endoscopic graspers/scissors will also be necessary.
- The surgeon will require an energy source, preferably the Ethicon Enseal®, Harmonic Scalpel or if those are unavailable, the L-Hook Cautery to create the pericardiotomy.

Indication for LAEE Procedure

The AtriClip LAA Exclusion System is indicated for the occlusion of the heart's left atrial appendage.

Contraindications for LAEE Procedure

PRO•V

1. Do not use this device as a contraceptive tubal occlusion device.

***Note:** Unlike the PRO2, the PRO•V's clip is made of 100% titanium, and may be used on a patient with a nickel allergy.



AtriClip Warnings

1. Do not attempt to reposition or remove the Clip after deployment. This may result in tissue damage or tearing.
2. Use this device only as intended. Failure to do so may result in injury to the user or patient.
3. Do not use on tissue which, in the opinion of the surgeon, would not be able to tolerate conventional suture materials or conventional closure techniques (such as surgical stapling).
4. Carefully evaluate Clip position, tissue thickness, and tissue width prior to Clip deployment. To determine appropriate Clip size, refer to the Cosgrove-Gillinov Selection Guide Instructions for Use. Failure to correctly size or deploy the Clip may result in: tissue trauma, dehiscence, tissue tearing, displacement and/or exclusion.

5. Do not use on a LAA less than 29 mm in width and 1.0 mm wall thickness. Doing so may result in: tissue trauma, dehiscence, tissue tearing, displacement and/or exclusion.
6. Do not use on a LAA greater than 50 mm when tissue is uncompressed. Doing so may result in incomplete occlusion of the structure.
7. Visually check for rust on the Applier jaws prior to use. The Applier should not be used for durations longer than 1 hour to prevent formation of rust. Failure to do so may result in a systematic adverse reaction.
8. The safety and effectiveness of this device in atrial rhythm control management, either alone or in combination with ablative treatment, has not been established.
9. AtriClip placement that allows blood flow into the LAA may not result in complete exclusion and/or electrical isolation.
10. Position and deploy Clip in a manner that provides clear visualization of all tissues being accessed. Poor visualization may result in suboptimal placement.
11. Take care to minimize manipulation of the LAA and Clip after Clip deployment.
12. It is recommended that the Clip be deployed in a dry field.
13. Do not use the Clip in temperatures below 20°C. Application of the Clip in temperatures below 20°C may affect device performance.
14. Do not attempt to articulate the End Effector while in the locked position. Force applied while in the locked position may cause damage to the device.

AtriClip Selection/Sizing

1. Using the Gillinov-Cosgrove Selection Guide, to determine correct selection of the PRO•V Clip. Clip sizes are located on the device package.

AtriClip Precautions

1. Read all instructions carefully for the AtriClip LAA Exclusion System. Failure to properly follow instructions may result in improper functioning of the device.
2. Use of the device should be limited to properly trained and qualified medical personnel.
3. Note that variations in specific procedures may occur due to individual physician techniques and patient anatomy.
4. Do not drop or toss the device as this may induce damage to the device. If the device is dropped, do not use. Replace with a new device.
5. DO NOT RESTERILIZE. The AtriClip LAA Exclusion System is provided STERILE and is intended for SINGLE use only. Re-sterilization may cause loss of function or injury to the patient.
6. Carefully consider any pre-surgical treatment the patient may have undergone and in corresponding selection of Clip size. Preoperative radiotherapy may result in changes to tissue. These changes may, for example, cause the tissue thickness to exceed the indicated range for the selected Clip size.
7. Do not modify this instrument. Use of a modified device may result in improper instrument function. AtriCure, Inc. makes no claim or representation as to the performance characteristics of this product if any modifications have been made to the AtriClip LAA Exclusion System.
8. Do not kink or excessively bend the shaft as this may affect device performance.
9. Evacuate thrombus from the LAA prior to Clip application as with other conventional LAA occlusion surgical techniques. Evaluating for the presence of thrombus should be done per the surgeon's discretion and standard of care.

Clip Size	LAA Size Range
35 mm	29-35 mm
40 mm	34-40 mm
45 mm	39-45 mm
50 mm	44-50 mm

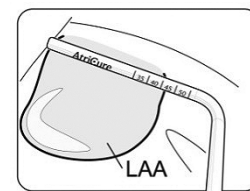

Note: When using the PRO•V device, size up 5 mm on the device after measuring the base of the LAA. (Example – if LAA base measures 40 mm, select the 45 mm PRO•V device).

2. Using sterile technique, remove the AtriClip LAA exclusion System from its packaging.
3. Using the Activation Lever on the handle, gently open and close the Clip to assure proper function.

Articulation of End Effector

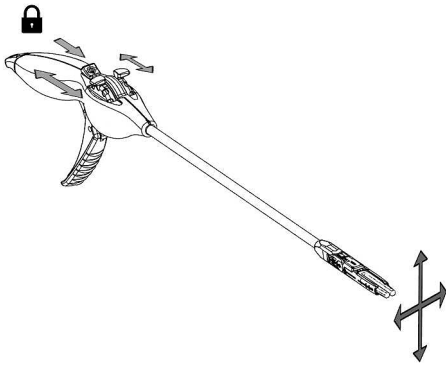

4. By pushing down and pulling the Articulation Lock backwards (proximal), the End Effector of the AtriClip LAA Exclusion System may be manually articulated up and down and side-to-side by either the articulation levers or pressing on the end effector. The Clip and End Effector can articulate 30° left or right and 60° up or down to take into account anatomical variations in the patient's anatomy.
5. To lock the End-Effector in position, press the Articulation Lock forward.

Clip Positioning

6. With the clip in the closed position, maneuver the AtriClip LAA Exclusion System into the targeted dissection plane.
7. Gently open the Clip by squeezing the Activation Lever.

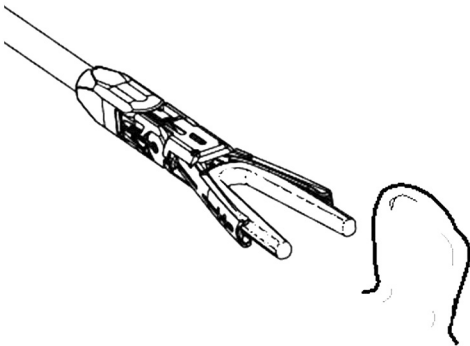

Note: The Clip automatically locks in the fully open position by means of a Locking Trigger on the handle of the device. The lock can be disengaged by pressing the Lever Release Trigger.

8. Gently position the Clip at the base of the LAA.

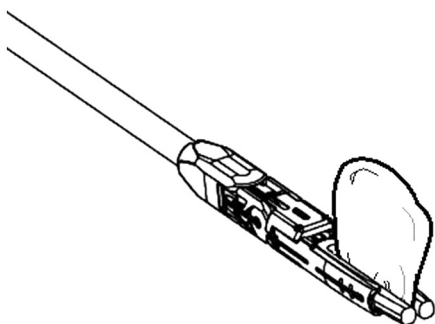

9. Position the Clip in a manner that provides clear visualization of all tissues being accessed.
10. While the Clip is still affixed to the Deployment Device, ensure that no surrounding structures interfere with or are damaged by the Clip, and that the Clip is placed correctly.
11. After the Clip is positioned correctly, grasp the Activation Lever and depress the Lever Release Trigger and slowly release the Activation Lever allowing the Clip to close.
12. If the Clip is not placed correctly, gently open the Clip and reposition as needed.

Deployment

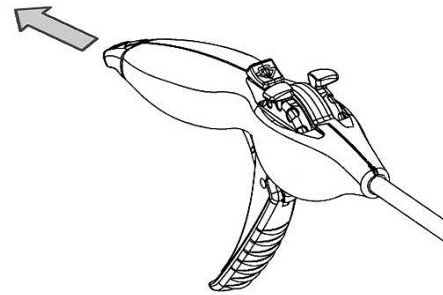

13. Deploy the Clip by slowly pulling the Deployment Tab at the proximal end of the handle.
Note: The Deployment Tab with steel cables may be completely removed from the end of the Handle.
14. Unlock the End Effector and carefully remove it from the LAA as shown below, leaving the Clip and attachment suture behind.

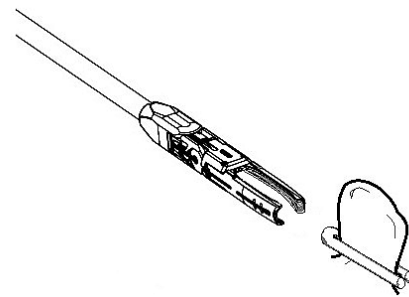

Caution: After pulling the Deployment Tab, the AtriClip LAA Exclusion System cannot be used to reposition the Clip.

15. Discard the deployment device after use. Follow local governing ordinances and recycling plans regarding disposal or recycling of device components.

AtriCure Procedural Overview

- Pre-Op TEE is necessary to check for thrombus presence within the LAA.
- Common port placement is two 5 mm ports and one 12 mm port in the 2-6th ICS.
- Pericardium is opened to access LAA.

- The selection guide is used to size the base of the LAA.
- An endo-Kittner is used to atraumatically tease the LAA into the open implant.
- Handle activated to open the implant and advance it onto the base of the LAA. A TEE evaluation is used to confirm accurate placement. The device can be repositioned prior to deployment.
- Non-piercing application occludes the LAA. Woven polyester fabric covering, used extensively in cardiac implants, promotes tissue ingrowth and has shown to achieve complete encapsulation in 180 days form implant, without erosion to adjacent structures.
- Blake drain/chest tube placed within chest cavity and port incisions closed.
- In preclinical and clinical studies, the AtriClip device securely sealed the LAA orifice resulting in a smooth endothelial tissue surface within 90 days.

Attention: Physicians should implement a comprehensive anti-coagulation protocol including pre-operative, intra-operative and post-operative anticoagulation management to prevent potential thromboemboli.

Recommended Anticoagulation Regimen

Pre-Operative Anticoagulation Therapy:

- If patient is on NOAC/DOAC, consider stopping 24-48 hours prior to procedure
- If patient is on Warfarin, stop as per your protocol and bridge with Lovenox
- If the decision is to stop all Anticoagulation therapy more than 48 hours prior to procedure, consider bridging with Lovenox

Intra-Operative Anticoagulation Therapy:

- Bolus and/or heparin drip to maintain ACT >300
- Restart OAC therapy 4-6 hours after completion of epicardial ablation

Post-Operative Anticoagulation Therapy:

Anticoagulation management should be followed per the 2017 HRS Expert Consensus on Catheter and Surgical Ablation of Atrial Fibrillation, including:

- Systemic anticoagulation therapy should be initiated for all patients post procedure, through at least two months following the ablation procedure
- Decisions regarding the use of systemic anticoagulation more than two months following ablation should be based on the patient's risk factors for stroke and not on the presence or type of AF

Best Practices for Stepwise Process of LAA Exclusion Procedure

Patient Positioning

- When LAEE is being performed concomitantly with the Hybrid AF Convergent procedure, the patient may be prepped and draped in a sterile fashion while lying supine on the operating room table.
- Defibrillator pads should be present and placed on the patient's right anterior chest and left mid-thoracic posterior surface, with the 1-amp grounding pad placed on the patient's left flank for the anticipated Convergent procedure.
- A deflated IV pressure bag should be present under the patient's left scapula, as to inflate while the patient is being prepped and also during LAA ligation to expose the left lateral chest, and then deflate during the Convergent portion of the procedure.
- With the IV pressure bag under the patient's left scapula, ensure their left side is at the edge of the OR table and their left arm is tucked in a hammock orientation, in order to fully expose the left lateral chest. After this is accomplished, inflate the IV pressure bag and have the patient prepped from chin to knees, with the left lateral chest exposed. This allows the surgeon to perform both procedures without compromising sterility or repositioning.

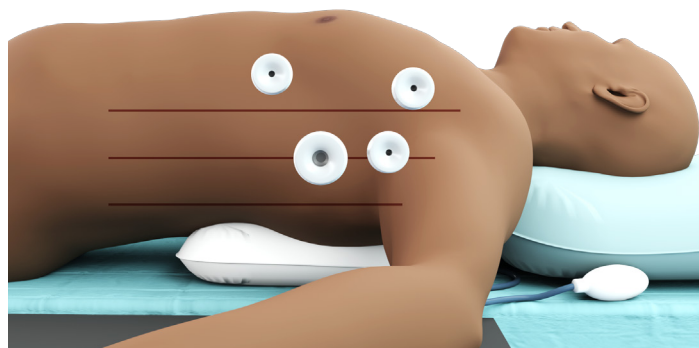
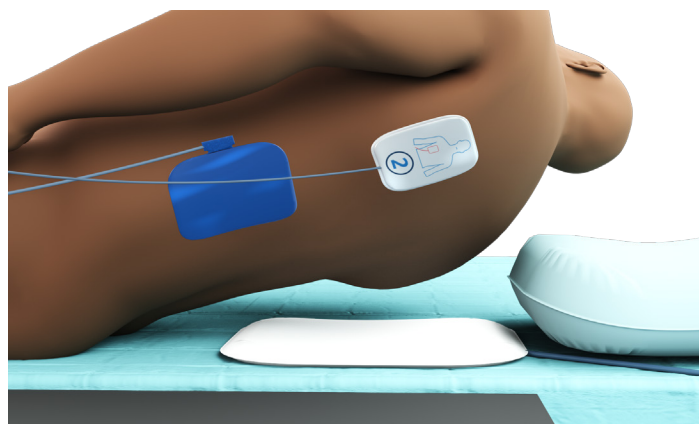

Anesthesia Considerations

- Double Lumen Tube or Bronchial Blocker will need to be utilized for single-lung ventilation. Ensure the patient will tolerate single-lung ventilation prior to committing to making a surgical incision.
- A TEE will need to be performed at the beginning of the procedure in order to rule out thrombus in the LAA – ideally performed before placement of central line. The most helpful degrees utilized to evaluate the LAA are 0°, 45°, 90° and 135°.
- There will be pressure changes when the pericardial incision is made as a pneumopericardium will develop when the CO₂ enters the pericardium.
- Unless contraindicated, the patient's systemic blood pressure should be elevated when opening the pericardium. It is recommended that a drop in blood pressure be treated with a pharmacological agent of choice, as needed.

Left Chest Access/Port Placement

First port

- Place the 5 mm port at the mid-axillary line in the 4th ICS. Be sure to examine CT/CXR prior to surgery, to evaluate proximity of left ventricle to chest wall. Attach CO₂ to port - pressure of 8 mmHg and flow of 20 L/min recommended. With 30° camera attached, look cranially towards 2nd ICS space.

Second port

- Place another 5 mm port at the mid-clavicular line in the 2nd ICS. Confirm placement and trajectory with palpation and/or by inserting a spinal needle, visualize with camera in 4th ICS port. Move the camera to the 2nd ICS port and look caudally down the rib cage towards the diaphragm.

Third port

- With the camera in the 2nd ICS port looking down the rib line, palpate at the mid-to-posterior axillary line and place a 12 mm port in the 6th or 7th ICS, with the port oriented towards the heart.

Fourth port

- Option 1: 5 mm port in the 6th ICS at the mid-clavicular line OR
- Option 2: 5 mm port in the 3rd ICS (between 2nd and 4th ICS ports) which can be utilized to help with retracting the pericardium during clip placement.
- The Camera Port is typically the 4th ICS port while the 2nd and the 6th are the working ports.

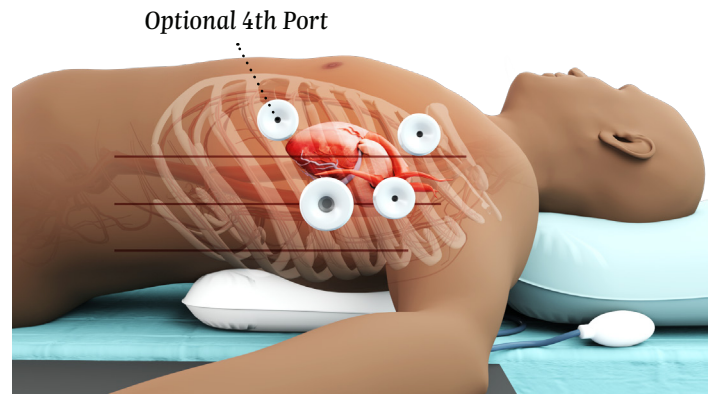

Pericardial Access

- With your ports placed and camera in the 4th ICS, you must gain entrance into the pericardium. After making an initial defect in the pericardium near the left ventricle, select your energy device for pericardiectomy and extend your defect cranially towards the left pulmonary artery.
- Ensure that you stay at least 1-2 cm posterior to the phrenic nerve as you move cranially with your incision.
- To help release tension on the anterior side of your incision, create a “L-shaped” flap by extending the base of your pericardiectomy and direct it posteriorly.
- If necessary, an Endo stitch™ device can be utilized to suspend the pericardium, if excessive fat is present.
- Insert the AtriClip selection guide, and measure the base of the left atrial appendage for appropriate Clip size.

***Note:** There is a band of tissue that runs from the left superior pulmonary vein (LSPV) to the left pulmonary artery, known as the Ligament of Marshall. This is considered an arrhythmogenic structure and the patient may experience AF burden reduction if the ligament is able to be divided. You may also gain entrance to the transverse sinus and create more space for device placement by eliminating this structure.

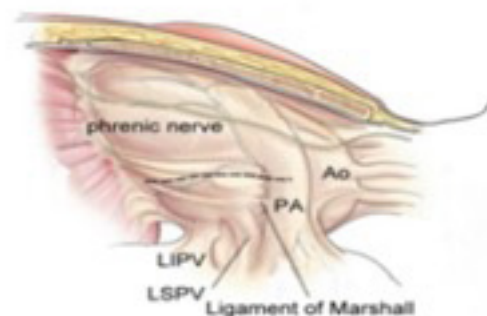

Device Placement

- When it is time to place the AtriClip PRO•V Exclusion Device, make sure you examine it prior to inserting it into the chest. Ensure that you are aware of the articulation dials and how they are controlled.
- The AtriClip device should be straight and locked when inserted into the 12 mm port. While utilizing an endoscopic Kittner or endograsper through the 2nd ICS, retract the edge of the pericardium to fully expose the LAA.
- Unlock the Articulation Lock and utilize the Articulation dials on the device handle to match the angle in which the LAA is oriented on the left atrium, then lock the Articulation Lock so the Clip's orientation isn't altered by bumping into surrounding anatomy.
- Place the PRO•V Clip at the base of the LAA, squeeze the Activation Lever and slide the Clip across the base of the appendage. Ensure that the tip of the Clip is distal to the base of the LAA to ensure complete capture of the appendage. Placing the very distal part of the PRO•V AtriClip beneath the pulmonary artery will give the device stability.
- At this point, there should be an endo Kittner in the 2nd ICS that you can use to gently tease the appendage into the Clip. Ensure you have the distal tip of the LAA within the clip and then sweep the Kittner along the lateral, medial and proximal edges of the appendage to ensure the entire LAA is collected.
**Note: NEVER use a grasping tool on the LAA, as it may tear the appendage leading to bleeding/potential harm to the patient.*
- Once you believe your clip is at the base of the appendage, fully release the Activation Lever and insert TEE probe to check for any gap greater than 1 cm from the clip to the opening of the appendage. If there is >1 cm gap, partially squeeze the Activation Lever and use the Kittner to sweep the medial and lateral sides of the appendage to pull any residual appendage tissue into the Clip.

When evaluating the final positioning of the Clip, there are 3 key steps to ensure successful placement:

1. *Completely let go of the device.* This seems counterintuitive, but in some instances, while placing the clip, there is a tendency to push down on the appendage with the device, creating a false positive closure. If you keep your hand on the device, then pull the Deployment Tab, there may be extra tissue that was originally not identified on TEE.
2. *Check TEE at 0°, 45°, 90° and 135°* to make sure all facets of the LAA are contained within the AtriClip.
3. *Wait at least 45 seconds before deploying device.* This will allow time to ensure the circumflex artery isn't compromised. Check ECG to rule out any acute ST-elevation.

Once the TEE is read, and there is less than 1 cm between the clip and the opening of the appendage, you may pull the Deployment Tab. Continue to utilize your Kittner and give counter traction on the Clip as you pull the device out of the chest.

The easiest way to remove the device from the chest is to unlock the device and retract slowly. **Note:** Do NOT squeeze the Activation Lever after deployment of Clip, because it will open the jaws of the device and be difficult to pull out of port.

Closing the Sites of Access

Chest incisions will be closed in standard fashion after placement of your choice of 19/24 Blake drain or chest tube.

References

1. Kamohara, K. et al . (2005). A novel device for left atrial appendage exclusion. J Thorac Cardiovasc Surg, 130(6):1639-44.
2. Kamohara, K. et al. (2006). Evaluation of a novel device for left atrial appendage exclusion: the second-generation atrial exclusion device. J Thorac Cardiovasc Surg, 132(2):340-6.
3. Starck, C.T. et al. (2012). Epicardial left atrial appendage clip occlusion also provides the electrical isolation of the left atrial appendage. Interactive CardioVascular and Thoracic Surgery, 15(3):416-8.

AtriClip PRO2 LAA Exclusion System

Overview

Minimally invasive thoracic surgery, utilizing a video-assisted thoracoscopic approach, requires three to four incisions to place ports into the requisite intercostal spaces. The Gillinov-Cosgrove AtriClip PRO2 allows for closed-chest LAA (left atrial appendage) exclusion and subsequent LAA electrical isolation from the left atrium.

Port placement in the lateral left chest wall allows access to the pericardium for creation of pericardiotomy and LAA ligation. Accessing the heart in this manner permits the surgeon to gain entrance to the pericardium and place an AtriClip device at the base of the LAA, in the absence of an open sternotomy procedure.

Product Description

The AtriClip LAA Exclusion System contains the Gillinov-Cosgrove LAA Clip for occlusion of the heart's left atrial appendage (LAA). Preclinical animal studies (Kamohara 2005, 2006) demonstrate that complete exclusion with the Clip also results in acute and chronic electrical isolation of the LAA. A human clinical study (Starck 2012) has demonstrated acute electrical isolation. Chronic electrical isolation has not been evaluated in human clinical studies. The Clip is pre-loaded on a disposable Clip applicator. The AtriClip LAA Exclusion System with preloaded Gillinov-Cosgrove Clip does not contain natural rubber latex components.

The AtriClip LAA Exclusion Device features Active Articulation Levers, Articulation Lock, Ambidextrous Lever/Release Trigger, Vertical/Lateral Movement, Rigid Shaft and quick release Deployment Tab for Exclusion Device placement.

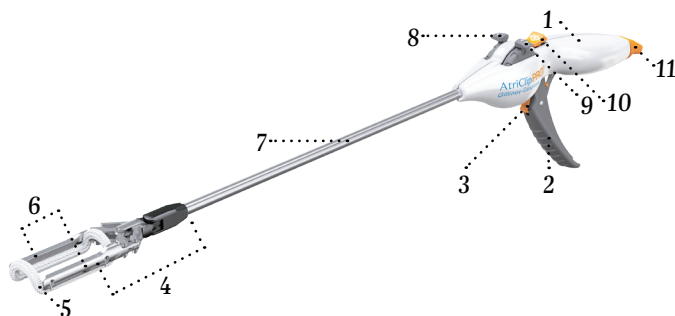

1	Handle	7	Shaft
2	Activation Lever	8	Up/Down Articulation
3	Lever Release Trigger	9	Left/Right Articulation
4	End Effector	10	Articulation Lock
5	Gillinov-Cosgrove LAA Clip	11	Deployment Tab
6	Clip Opening Jaws		

Equipment Required

Additional supplies will be necessary when the VATS LAA ligation procedure is performed concomitantly with the Hybrid AF™ Convergent procedure.

- A 30° 5 mm scope for visualization with insufflation tubing, (3x) 5 mm ports and (1x) 12 mm port for chest access. Endoscopic Kittners, suction irrigator, endoscopic graspers/scissors will also be necessary.
- The surgeon will require an energy source, preferably the Ethicon Enseal®, Harmonic Scalpel or if those are unavailable, the L-Hook Cautery to create the pericardiotomy.

Indication for LAEE Procedure

The AtriClip LAA Exclusion System is indicated for the occlusion of the heart's left atrial appendage.

Contraindications for LAEE Procedure

PRO2

1. Do not use this device as a contraceptive tubal occlusion device.
2. Do not use this device if the patient has a known allergy to Nitinol (nickel titanium alloy).



AtriClip Warnings

1. Do not attempt to reposition or remove the Clip after deployment. This may result in tissue damage or tearing.
2. Use this device only as intended. Failure to do so may result in injury to the user or patient.
3. Do not use on tissue which, in the opinion of the surgeon, would not be able to tolerate conventional suture materials or conventional closure techniques (such as surgical stapling). Doing so may result in: tissue trauma, dehiscence, tissue tearing, displacement and/or exclusion.
4. Carefully evaluate Clip position, tissue thickness, and tissue width prior to Clip deployment. To determine appropriate Clip size, refer to the Cosgrove-Gillinov Selection Guide Instructions for Use. Failure to

correctly size or deploy the Clip may result in: tissue trauma, dehiscence, tissue tearing, displacement and/or exclusion.

5. Do not use on a LAA less than 29 mm in width and 1.0 mm wall thickness. Doing so may result in: tissue trauma, dehiscence, tissue tearing, displacement, and/or exclusion.
6. Do not use on a LAA greater than 50 mm when tissue is uncompressed. Doing so may result in incomplete occlusion of the structure.
7. Do not use this device if the patient has sensitivity to Nickel (nickel titanium alloy). This may result in an adverse user or patient reaction.
8. Visually check for rust on the Applier jaws prior to use. The Applier should not be used for durations longer than 1 hour to prevent formation of rust.
9. The safety and effectiveness of this device is atrial rhythm control management, either alone or in combination with other ablative treatment, has not been established.
10. AtriClip placement that allows blood flow into the LAA may not result in complete exclusion and/or electrical isolation.

application as with other conventional LAA occlusion surgical techniques. Evaluating for the presence of thrombus should be done per the surgeon's discretion and standard of care.

10. Position and deploy Clip in a manner that provides clear visualization of all tissues being accessed. Poor visualization may result in suboptimal placement.
11. Take care to minimize manipulation of the LAA and Clip after Clip deployment.
12. It is recommended that the Clip be deployed in a dry field.
13. Do not use the Clip in temperatures below 20°C. Application of the Clip in temperatures below 20°C may affect device performance.
14. Do not attempt to articulate the End Effector while in the locked position. Force applied while in the locked position may cause damage to the device.

AtriClip Precautions

1. Read all instructions carefully for the AtriClip LAA Exclusion System. Failure to properly follow instructions may result in improper functioning of the device.
2. Use of the device should be limited to properly trained and qualified medical personnel.
3. Note that variations in specific procedures may occur due to individual physician techniques and patient anatomy.
4. Do not drop or toss the device as this may induce damage to the device. If the device is dropped, do not use. Replace with a new device.
5. DO NOT RESTERILIZE. The AtriClip LAA Exclusion System is provided STERILE and is intended for SINGLE use only. Re-sterilization may cause loss of function or injury to the patient.
6. Carefully consider any pre-surgical treatment the patient may have undergone and in corresponding selection of Clip size. Preoperative radiotherapy may result in changes to tissue. These changes may, for example, cause the tissue thickness to exceed the indicated range for the selected Clip size.
7. Do not modify this instrument. Use of a modified device may result in improper instrument function. AtriCure, Inc. makes no claim or representation as to the performance characteristics of this product if any modifications have been made to the AtriClip LAA Exclusion System.
8. Do not kink or excessively bend the shaft as this may affect device performance.
9. Evacuate thrombus from the LAA prior to Clip

AtriClip Selection/Sizing

1. Using the Gillinov-Cosgrove Selection Guide, to determine correct selection of the Gillinov-Cosgrove LAA Clip. Clip sizes are located on the device package.

Clip Size	LAA Size Range
35 mm	29-35 mm
40 mm	34-40 mm
45 mm	39-45 mm
50 mm	44-50 mm

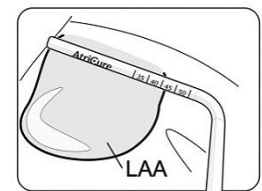

2. Using sterile technique, remove the AtriClip LAA exclusion System from its packaging.
3. Using the Activation Lever on the handle, gently open and close the Clip to assure proper function. **Caution:** Do not open and close the Clip more than 3 times with the activation lever prior to deployment.

Articulation of End Effector

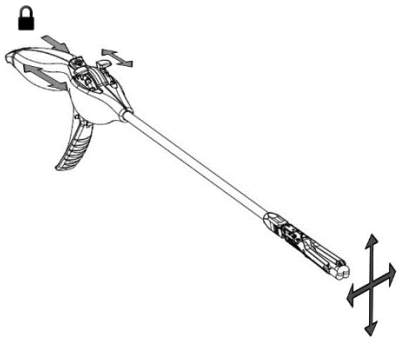

4. By pushing down and pulling the Articulation Lock backwards (proximal), the End Effector of the AtriClip LAA Exclusion System may be manually articulated up and down and side-to-side by either the articulation levers or pressing on the end effector. The Clip and End Effector can articulate 30° left or right and 30° up or down to take into account anatomical variations in the patient's anatomy.
5. To lock the End-Effector in position, press the Articulation Lock forward.

Clip Positioning

6. Maneuver the LAA Exclusion System into the targeted dissection plane.

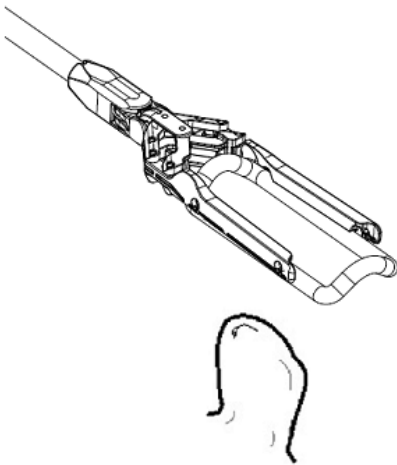

7. Gently open the Clip by squeezing the Activation Lever.
Note: The Clip automatically locks in the fully open position by means of a Locking Trigger on the handle of the device. The lock can be disengaged by pressing the Lever Release Trigger.
8. Orient the Clip applicator with pre-loaded Clip at the tip of LAA with the loops at the ends of the Clip pointed away from the LAA.

9. Gently position the Clip at the base of the LAA.

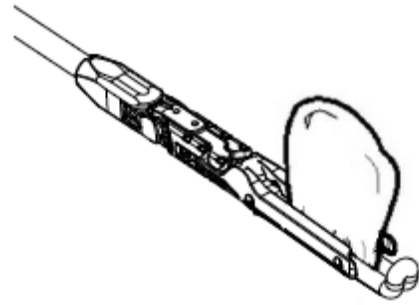

10. Position the Clip in a manner that provides clear visualization of all tissues being accessed.
11. While the Clip is still affixed to the Deployment Device, ensure that no surrounding structures interfere with or are damaged by the Clip, and that the Clip is placed correctly.
12. If the Clip is not placed correctly, gently open the Clip and reposition as needed.
13. After the Clip is positioned correctly, grasp the Activation Lever and depress the Lever Release Trigger and slowly release the Activation Lever allowing the Clip to close.

Deployment

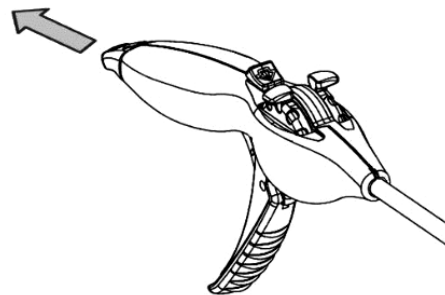

14. Deploy the Clip by slowly pulling the Deployment Tab at the proximal end of the handle. Note: The Deployment Tab with steel cables may be completely removed from the end of the Handle.
15. Unlock the End Effector articulation and carefully remove it from the LAA as shown below leaving the Clip and attachment suture behind.
Caution: After pulling the Deployment Tab, the AtriClip LAA Exclusion System cannot be used to reposition the Clip.

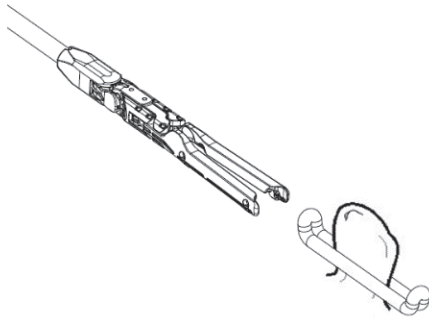

- Discard the deployment device after use. Follow local governing ordinances and recycling plans regarding disposal or recycling of device components.

AtriCure Procedural Overview

- Pre-Op TEE is necessary to check for thrombus presence within the LAA.
- Common port placement is two 5 mm ports and one 12 mm port in the 2-6th ICS.
- Pericardium is opened to access LAA.
- The selection guide is used to size the base of the LAA.
- An endo-Kittner is used to atraumatically tease the LAA into the open implant.
- Handle activated to open the implant and advance it onto the base of the LAA. A TEE evaluation is used to confirm accurate placement. The device can be repositioned prior to deployment.
- Non-piercing application occludes the LAA. Woven polyester fabric covering, used extensively in cardiac implants, promotes tissue ingrowth and has shown to achieve complete encapsulation in 180 days form implant, without erosion to adjacent structures.
- Blake drain/chest tube placed within chest cavity and port incisions closed.
- In preclinical and clinical studies, the AtriClip device securely sealed the LAA orifice resulting in a smooth endothelial tissue surface within 90 days.

Attention: Physicians should implement a comprehensive anti-coagulation protocol including pre-operative, intra-operative and post-operative anticoagulation management to prevent potential thromboemboli.

Recommended Anticoagulation Regimen

Pre-Operative Anticoagulation Therapy:

- If patient is on NOAC/DOAC, consider stopping 24-48 hours prior to procedure
- If patient is on Warfarin, stop as per your protocol and bridge with Lovenox
- If the decision is to stop all Anticoagulation therapy more than 48 hours prior to procedure, consider bridging with Lovenox

Intra-Operative Anticoagulation Therapy:

- Bolus and/or heparin drip to maintain ACT >300
- Restart OAC therapy 4-6 hours after completion of epicardial ablation

Post-Operative Anticoagulation Therapy:

Anticoagulation management should be followed per the 2017 HRS Expert Consensus on Catheter and Surgical Ablation of Atrial Fibrillation, including:

- Systemic anticoagulation therapy should be initiated for all patients post procedure, through at least two months following the ablation procedure
- Decisions regarding the use of systemic anticoagulation more than two months following ablation should be based on the patient's risk factors for stroke and not on the presence or type of AF

Best Practices for Stepwise Process of LAA Exclusion Procedure:

Patient Positioning

- When LAAE is being performed concomitantly with the Hybrid AF Convergent procedure, the patient may be prepped and draped in a sterile fashion while lying supine on the operating room table.
- Defibrillator pads should be present and placed on the patient's right anterior chest and left mid-thoracic posterior surface, with the 1-amp grounding pad placed on the patient's left flank for the anticipated Convergent procedure.
- A deflated IV pressure bag should be present under the patient's left scapula, as to inflate while the patient is being prepped and also during LAA ligation to expose the left lateral chest, and then deflate during the Convergent portion of the procedure.
- With the IV pressure bag under the patient's left scapula, ensure their left side is at the edge of the OR table and their left arm is tucked in a hammock orientation, in order to fully expose the left lateral chest. After this is accomplished, inflate the IV pressure bag and have the patient prepped from chin to knees, with the left lateral chest exposed. This allows the surgeon to perform both procedures without compromising sterility or repositioning.

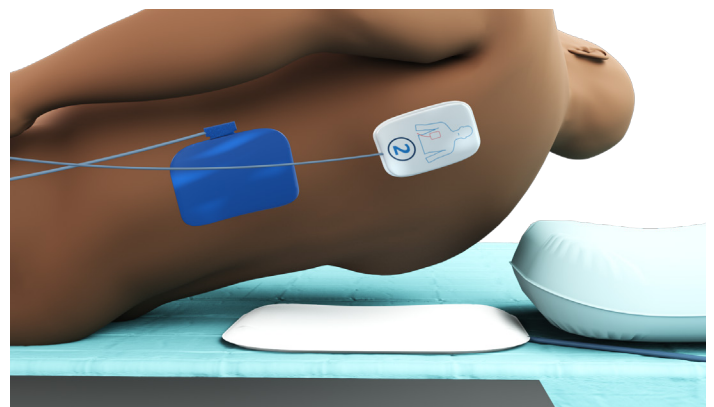

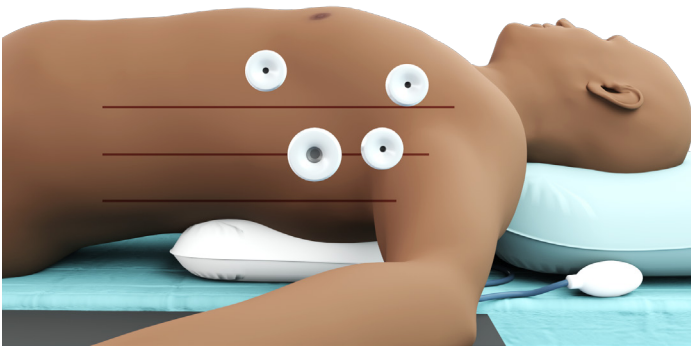

Anesthesia Considerations

- Double Lumen Tube or Bronchial Blocker will need to be utilized for single-lung ventilation. Ensure the patient will tolerate single-lung ventilation prior to committing to making a surgical incision.
- A TEE will need to be performed at the beginning of the procedure in order to rule out thrombus in the LAA – ideally performed before placement of central line. The most helpful degrees utilized to evaluate the LAA are 0°, 45°, 90° and 135°.
- There will be pressure changes when the pericardial incision is made as a pneumopericardium will develop when the CO₂ enters the pericardium.
- Unless contraindicated, the patient’s systemic blood pressure should be elevated when opening the pericardium. It is recommended that a drop in blood pressure be treated with a pharmacological agent of choice, as needed.

Left Chest Access/Port Placement

First port

- Place the 5 mm port at the mid-axillary line in the 4th ICS. Be sure to examine CT/CXR prior to surgery, to evaluate proximity of left ventricle to chest wall. Attach CO₂ to port - pressure of 8 mmHg and flow of 20 L/min recommended. With 30° camera attached, look cranially towards 2nd ICS space.

Second port

- Place another 5 mm port at the mid-clavicular line in the 2nd ICS. Confirm placement and trajectory with palpation and/or by inserting a spinal needle, visualize with camera in 4th ICS port. Move the camera to the 2nd ICS port and look caudally down the rib cage towards the diaphragm.

Third port

- With the camera in the 2nd ICS port looking down the rib line, palpate at the mid-to-posterior axillary line and place a 12 mm port in the 6th or 7th ICS, with the port oriented towards the heart.

Fourth port

- Option 1: 5 mm port in the 6th ICS at the mid-clavicular line OR
- Option 2: 5 mm port in the 3rd ICS (between 2nd and 4th ICS ports) which can be utilized to help with retracting the pericardium during clip placement.
- The Camera Port is typically the 4th ICS port while the 2nd and the 6th are the working ports.

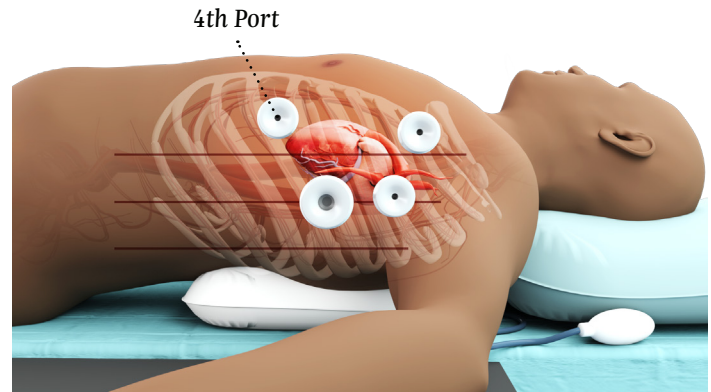

Pericardial Access

- With your ports placed and camera in the 4th ICS, you must gain entrance into the pericardium. After making an initial defect in the pericardium near the left ventricle, select your energy device for pericardiectomy and extend your defect cranially towards the left pulmonary artery.
- Ensure that you stay at least 1-2 cm posterior to the phrenic nerve as you move cranially with your incision.
- To help release tension on the anterior side of your incision, create a “L-shaped” flap by extending the base of your pericardiectomy and direct it posteriorly.
- If necessary, an Endo stitch™ device can be utilized to suspend the pericardium, if excessive fat is present.
- Insert the AtriClip selection guide, and measure the base of the left atrial appendage for appropriate Clip size.

***Note:** There is a band of tissue that runs from the left superior pulmonary vein (LSPV) to the left pulmonary artery, known as the *Ligament of Marshall*. This is considered an arrhythmogenic structure and the patient may experience AF burden reduction if the ligament is able to be divided. You may also gain entrance to the transverse sinus and create more space for device placement by eliminating this structure.

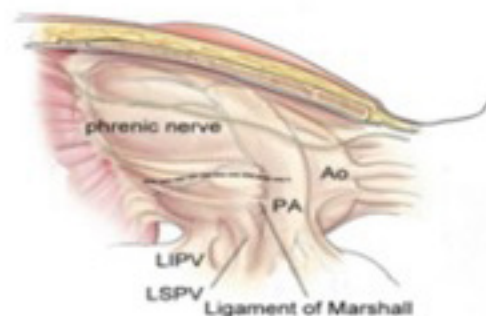

Device Placement

- When it is time to place the Gillinov-Cosgrove AtriClip PRO2 Exclusion Device, make sure you examine it prior to inserting it into the chest. Ensure that you are aware of the articulation dials and how they are controlled.
- The AtriClip device should be straight and locked when inserted into the 12mm port. While utilizing an endoscopic Kittner or endograsper through the 2nd ICS, retract the edge of the pericardium to fully expose the LAA.
- Unlock the Articulation Lock and utilize the Articulation dials on the device handle to match the angle in which the LAA is oriented on the left atrium, then lock the Articulation Lock so the Clip's orientation isn't altered by bumping into surrounding anatomy.
- Hover the Clip over the LAA and squeeze the Activation Lever to open the PRO2 clip and lower it over the tip of the left atrial appendage. Placing the very distal part of the PRO2 AtriClip beneath the pulmonary artery will give the device stability.
- At this point, there should be an endo Kittner in the 2nd ICS that you can use to gently tease the appendage into the Clip. Ensure you have the distal tip of the LAA within the clip and then sweep the Kittner along the lateral, medial and proximal edges of the appendage to ensure the entire LAA is collected.
**Note: NEVER use a grasping tool on the LAA, as it may tear the appendage leading to bleeding/potential harm to the patient.*
- Once you believe you have worked the Clip down to the base of the appendage, fully release the Activation Lever and insert TEE probe to check for any gap greater than 1 cm from the clip to the opening of the appendage. If there is >1 cm gap, partially squeeze the Activation Lever and use the Kittner to sweep the medial and lateral sides of the appendage to pull any residual appendage tissue into the Clip.

When evaluating the final positioning of the Clip, there are 3 key steps to ensure successful placement:

1. *Completely let go of the device.* This seems counterintuitive, but in some instances, while placing the clip, there is a tendency to push down on the appendage with the device, creating a false positive closure. If you keep your hand on the device, then pull the Deployment Tab, there may be extra tissue that was originally not identified on TEE.
2. *Check TEE at 0°, 45°, 90° and 135°* to make sure all facets of the LAA are contained within the AtriClip.
3. *Wait at least 45 seconds before deploying device.* This will allow time to ensure the circumflex artery isn't compromised. Check ECG to rule out any acute ST-elevation.

Once the TEE is read, and there is less than 1 cm between the clip and the opening of the appendage, you may pull the Deployment Tab. Continue to utilize your Kittner and give counter traction on the Clip as you pull the device out of the chest.

The easiest way to remove the device from the chest is to unlock the device and retract slowly. **Note:** Do NOT squeeze the Activation Lever after deployment of Clip, because it will open the jaws of the device and be difficult to pull out of port.

Closing the Sites of Access

Chest incisions will be closed in standard fashion after placement of your choice of 19/24 Blake drain or chest tube.

References

1. Kamohara, K. et al. (2005). A novel device for left atrial appendage exclusion. *J Thorac Cardiovasc Surg*, 130(6):1639-44.
2. Kamohara, K. et al. (2006). Evaluation of a novel device for left atrial appendage exclusion: the second-generation atrial exclusion device. *J Thorac Cardiovasc Surg*, 132(2):340-6.
3. Starck, C.T. et al. (2012). Epicardial left atrial appendage clip occlusion also provides the electrical isolation of the left atrial appendage. *Interactive Cardiovascular and Thoracic Surgery*, 15(3):416-8.

Epi-Sense® ST™ Coagulation Device

EU Indications: The Epi-Sense ST™ Coagulation Device is indicated for the epicardial treatment of arrhythmias including atrial fibrillation (AF) when augmented with an endocardial ablation, with the aim to restore normal sinus rhythm, reduce AF symptoms, and improve quality of life.

AtriClip PRO•V® Device

EU Indications: The AtriClip™ LAA Exclusion System is indicated for the occlusion of the heart's left atrial appendage.

AtriClip PRO2® Device

EU Indications: The AtriClip™ LAA Exclusion System is indicated for the occlusion of the heart's left atrial appendage.

Please review the Instructions for Use for a complete listing of contraindications, warnings, precautions and potential adverse events prior to using these devices.

ATRICURE, INC.

7555 Innovation Way
Mason, OH 45040 USA
+1 (866) 349-2342
www.AtriCure.com

ATRICURE EUROPE B.V.

De Entree 260
1101 EE
Amsterdam
The Netherlands
Tel. : +31 (0) 20-7005560
Fax : +31 (0) 20-7005561
SalesSupportEU@AtriCure.com
Europe.AtriCure.com